

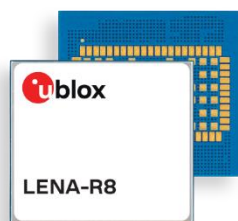

# LENA-R8 series

Multi-mode LTE Cat 1bis modules

Data sheet



## Abstract

The LENA-R8 cellular module features uncompromised global access in smallest form factor. With 14 LTE bands and four GSM/GPRS bands it offers universal network connectivity and global coverage. The integrated u-blox GNSS makes it ideal for demanding global tracking and telematic applications, and it enables simpler, smaller devices with no-compromise GNSS performance. Connectivity and location services are natively supported and offers customer simple and efficient solution for cloud-based services such as CaaS and LaaS.

# Document information

<b>Title</b>	<b>LENA-R8 series</b>	
<b>Subtitle</b>	Multi-mode LTE Cat 1bis modules	
<b>Document type</b>	Data sheet	
<b>Document number</b>	UBX-22003110	
<b>Revision and date</b>	R04	28-Sep-2023
<b>Disclosure restriction</b>	C1-Public	

<b>Product status</b>	<b>Corresponding content status</b>	
<b>Functional sample</b>	Draft	For functional testing. Revised and supplementary data will be published later.
<b>In development / Prototype</b>	Objective specification	Target values. Revised and supplementary data will be published later.
<b>Engineering sample</b>	Advance information	Data based on early testing. Revised and supplementary data will be published later.
<b>Initial production</b>	Early production information	Data from product verification. Revised and supplementary data may be published later.
<b>Mass production / End of life</b>	Production information	Document contains the final product specification.

This document applies to the following products:

<b>Product name</b>	<b>Type number</b>	<b>Firmware version</b>	<b>Notification reference</b>	<b>Product status</b>
LENA-R8001	LENA-R8001-00C-00	Modem: 02.00 Application: A01.40	UBXDOC-686885345-1771	Initial production
LENA-R8001M10	LENA-R8001M10-00C-00	Modem: 02.00 Application: A01.40	UBXDOC-686885345-1771	Initial production

u-blox or third parties may hold intellectual property rights in the products, names, logos and designs included in this document. Copying, reproduction, modification or disclosure to third parties of this document or any part thereof is only permitted with the express written permission of u-blox.

The information contained herein is provided "as is" and u-blox assumes no liability for its use. No warranty, either express or implied, is given, including but not limited to, with respect to the accuracy, correctness, reliability and fitness for a particular purpose of the information. This document may be revised by u-blox at any time without notice. For the most recent documents, visit [www.u-blox.com](http://www.u-blox.com).

Copyright © u-blox AG.

# Contents

<b>Document information</b> .....	<b>2</b>
<b>Contents</b> .....	<b>3</b>
<b>1 Functional description</b> .....	<b>6</b>
1.1 Overview.....	6
1.2 Product features .....	6
1.3 Block diagram .....	7
1.4 Product description .....	8
1.5 AT command and GNSS protocols support .....	8
1.6 Supported features .....	9
<b>2 Cellular subsystem interfaces</b> .....	<b>11</b>
2.1 Cellular power management.....	11
2.1.1 Cellular supply input (VCC) .....	11
2.1.2 Cellular RTC supply input / output (V_BCKP).....	11
2.1.3 Cellular generic digital interfaces supply output (V_INT).....	11
2.2 Cellular antenna interface.....	11
2.2.1 Cellular antenna RF interface (ANT).....	11
2.2.2 Cellular antenna detection (ANT_DET).....	11
2.2.3 Cellular antenna dynamic tuner interface .....	11
2.3 Cellular system functions .....	12
2.3.1 Cellular system power-on.....	12
2.3.2 Cellular system power-off.....	12
2.3.3 Cellular system reset .....	12
2.4 Cellular SIM interface .....	13
2.4.1 Cellular SIM card / chip interface.....	13
2.5 Cellular serial communication interfaces .....	13
2.5.1 Cellular UART interfaces.....	13
2.5.2 Cellular USB interface .....	14
2.5.3 Cellular I2C interface.....	15
2.6 Cellular audio interface .....	15
2.7 Cellular clock output.....	15
2.8 Cellular GPIO pins .....	15
2.9 Reserved pins.....	15
<b>3 GNSS subsystem interfaces</b> .....	<b>16</b>
3.1 GNSS power management.....	16
3.1.1 GNSS supply input (VCC_GNSS) .....	16
3.1.2 GNSS backup supply input (VBCKP_GNSS).....	16
3.2 GNSS antenna interface.....	16
3.2.1 GNSS antenna RF interface (ANT_GNSS).....	16
3.2.2 GNSS LNA or antenna on/off control (ANT_ON).....	16
3.3 GNSS serial communication interface .....	17

3.3.1	GNSS UART interface .....	17
3.4	GNSS peripheral input/output.....	17
<b>4</b>	<b>Pin definition .....</b>	<b>18</b>
4.1	Pin assignment.....	18
<b>5</b>	<b>Electrical specifications .....</b>	<b>23</b>
5.1	Absolute maximum rating.....	23
5.1.1	Maximum ESD.....	24
5.2	Operating conditions.....	24
5.2.1	Operating temperature range.....	24
5.2.2	Supply/power pins .....	24
5.2.3	Cellular current consumption.....	25
5.2.4	GNSS current consumption .....	25
5.2.5	GNSS characteristics and performances .....	26
5.2.6	Cellular LTE RF characteristics .....	27
5.2.7	Cellular 2G RF characteristics.....	28
5.2.8	Cellular ANT_DET pin.....	29
5.2.9	Cellular PWR_ON pin .....	29
5.2.10	Cellular RESET_N pin .....	29
5.2.11	Cellular SIM pins.....	29
5.2.12	Cellular USB pins.....	30
5.2.13	Cellular I2C pins.....	30
5.2.14	Cellular Generic Digital Interfaces pins .....	30
5.2.15	Cellular smart temperature supervisor.....	31
5.2.16	GNSS peripheral I/O pins .....	31
5.3	Parameters for ATEX applications .....	31
<b>6</b>	<b>Mechanical specifications .....</b>	<b>33</b>
<b>7</b>	<b>Qualification and approvals.....</b>	<b>34</b>
7.1	Reliability tests.....	34
7.2	Approvals.....	34
<b>8</b>	<b>Product handling &amp; soldering.....</b>	<b>35</b>
8.1	Packaging .....	35
8.1.1	Reels .....	35
8.1.2	Tapes.....	36
8.2	Moisture sensitivity levels.....	37
8.3	ESD precautions.....	37
8.4	Soldering.....	37
<b>9</b>	<b>Labeling and ordering information .....</b>	<b>38</b>
9.1	Product labeling.....	38
9.2	Explanation of codes .....	38
9.3	Ordering information.....	39
<b>Appendix .....</b>	<b>40</b>	
<b>A Glossary .....</b>	<b>40</b>	

**Related documentation ..... 43**  
**Revision history ..... 43**  
**Contact..... 44**



### 1.3 Block diagram

Figure 1 summarizes the internal architecture of the LENA-R8001 modules.

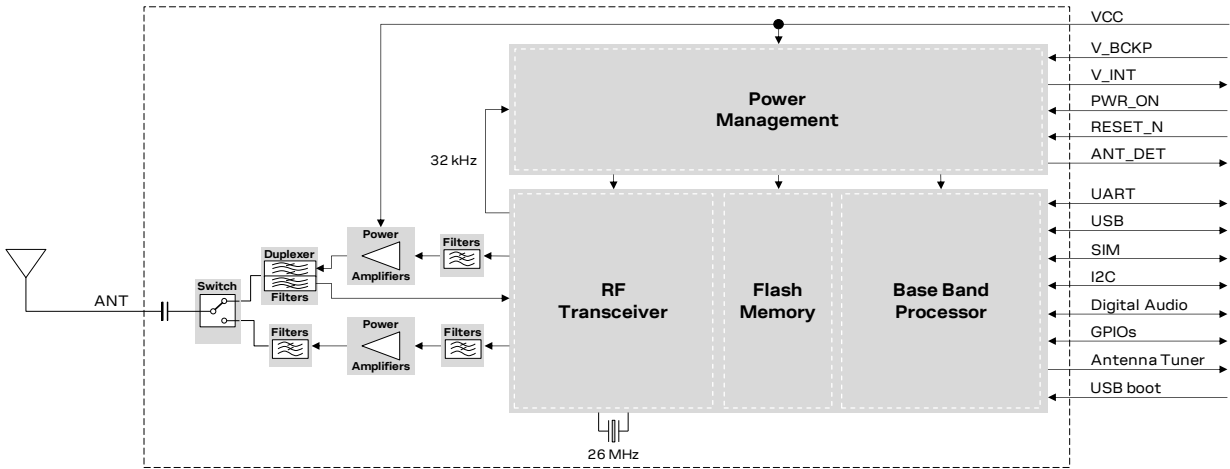

Figure 1: LENA-R8001 module block diagram

The LENA-R8001-00C product version does not support the antenna tuner interface (**RFCTRL1** and **RFCTRL2** pins) and the digital audio interface (**I2S\_TXD**, **I2S\_RXD**, **I2S\_CLK**, **I2S\_WA** pins).

Figure 2 summarizes the internal architecture of the LENA-R8001M10 modules.

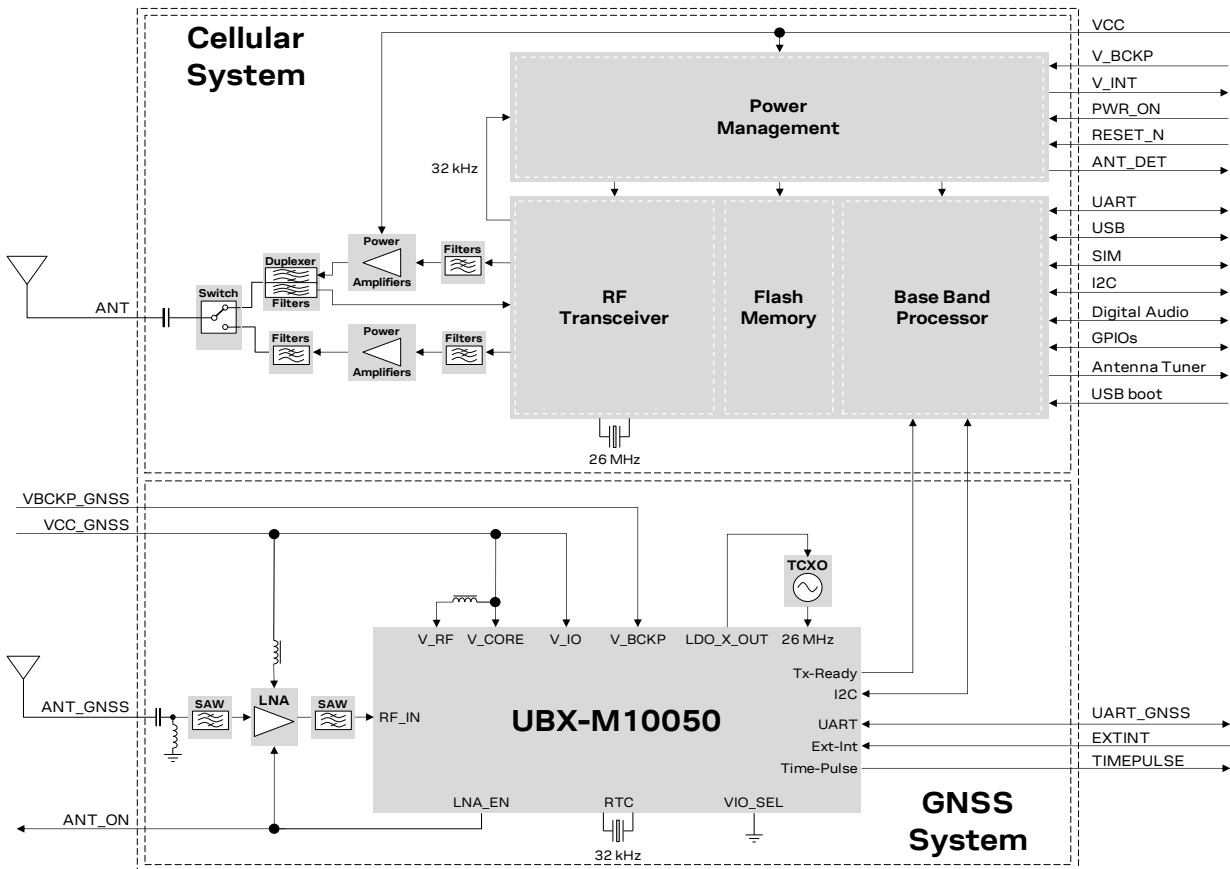

Figure 2: LENA-R8001M10 module block diagram

LENA-R8001M10-00C product version does not support the antenna tuner interface (**RFCTRL1** and **RFCTRL2** pins), the digital audio interface (**I2S\_TXD**, **I2S\_RXD**, **I2S\_CLK**, **I2S\_WA** pins), and the external I2C interface (**SDA** and **SCL** pins).

## 1.4 Product description

LENA-R8 series modules include 2 variants:

- The LENA-R8001 modules, integrating a cellular system supporting multi-band LTE Cat 1bis and 2G radio access technologies for global deployments
- The LENA-R8001M10 modules, integrating the same multi-band LTE Cat 1bis and 2G cellular system of LENA-R8001 modules plus a GNSS system based on the ultra-low-power u-blox M10 standard precision concurrent GNSS receiver. As illustrated in [Figure 2](#), the cellular and the GNSS are independent subsystems of the module, internally interconnected by dedicated I2C interface, with separate supply inputs and separate accessible interfaces for great usage flexibility, as each of the two subsystems can be operated fully independently.

Voice over LTE (VoLTE) and Circuit-Switched-Fall-Back (CSFB) call setup is supported without audio.

4G LTE	2G GSM/GPRS	GNSS (LENA-R8001M10 only)
3GPP Release 13 LTE Frequency and Time Division Duplex (FDD/TDD)	General Packet Radio Service (GPRS) Time Division Multiple Access (TDMA)	u-blox UBX-M10050-KB-A0100A GNSS receiver with concurrent reception of up to four GNSS
LTE bands: <ul style="list-style-type: none"> <li>• FDD band 12 (700 MHz)</li> <li>• FDD band 28 (700 MHz)</li> <li>• FDD band 20 (800 MHz)</li> <li>• FDD band 5 (850 MHz)</li> <li>• FDD band 8 (900 MHz)</li> <li>• FDD band 4 (1700 MHz)</li> <li>• FDD band 66 (1700 MHz)</li> <li>• FDD band 3 (1800 MHz)</li> <li>• FDD band 2 (1900 MHz)</li> <li>• FDD band 1 (2100 MHz)</li> <li>• FDD band 7 (2600 MHz)</li> <li>• TDD band 40 (2300 MHz)</li> <li>• TDD band 41 (2600 MHz)</li> <li>• TDD band 38 (2600 MHz)</li> </ul>	GSM/GPRS bands: <ul style="list-style-type: none"> <li>• GSM 850</li> <li>• E-GSM 900</li> <li>• DCS 1800</li> <li>• PCS 1900</li> </ul>	GNSS signals: <ul style="list-style-type: none"> <li>• GPS / QZSS L1C/A (1575.42 MHz)</li> <li>• Galileo E1-B/C (1575.42 MHz)</li> <li>• GLONASS L1OF (1602 MHz + <math>k \cdot 562.5</math> kHz, <math>k = -7, \dots, 5, 6</math>)</li> <li>• BeiDou B1I (1561.098 MHz), B1C (1575.42 MHz)</li> </ul> Augmentation systems: <ul style="list-style-type: none"> <li>• SBAS (EGNOS, GAGAN, MSAS, WAAS)</li> <li>• QZSS L1S (SLAS)</li> </ul>
LTE Power Class <ul style="list-style-type: none"> <li>• Power Class 3 (23 dBm)</li> </ul>	GSM/GPRS (GMSK) Power Class <ul style="list-style-type: none"> <li>• Class 4 (33 dBm) for low bands</li> <li>• Class 1 (30 dBm) for high bands</li> </ul>	Protocols: <ul style="list-style-type: none"> <li>• UBX u-blox proprietary</li> <li>• NMEA 2.1, 2.3, 4.0, 4.10 and 4.11 (default)</li> </ul>
Data rate <ul style="list-style-type: none"> <li>• LTE category 1bis: up to 10.3 Mbit/s DL, up to 5.2 Mbit/s UL</li> </ul>	Data rate <ul style="list-style-type: none"> <li>• GPRS multi-slot class 12<sup>1</sup>: up to 85.6 kbit/s DL, up to 85.6 kbit/s UL</li> </ul>	Assisted GNSS services: <ul style="list-style-type: none"> <li>• AssistNow Online</li> <li>• AssistNow Offline</li> <li>• AssistNow Autonomous</li> </ul>

**Table 2: LENA-R8 series LTE, 2G and GNSS characteristics summary**

## 1.5 AT command and GNSS protocols support

The cellular subsystem of LENA-R8 series modules support AT commands according to the 3GPP standards TS 27.007 [7], TS 27.005 [8] and the u-blox AT command extension.

 For a complete list of supported AT commands, see the AT commands manual [1].

The GNSS subsystem of LENA-R8001M10 modules can be controlled and operated using the u-blox proprietary UBX protocol and the standard NMEA protocol.

 For a complete list of supported GNSS protocols, see the u-blox M10 interface description [5].



<sup>1</sup> GPRS multi-slot class 12 implies a maximum of 4 slots in DL (reception), 4 slots in UL (transmission) with 5 slots in total.



## 1.6 Supported features

Table 3 lists some of the main features supported by LENA-R8 series modules. [2]

Feature	Description
Device security	Device security features include: <ul style="list-style-type: none"> <li>Secure boot: software authenticity and integrity</li> <li>Secure update: secure delivery of the correct FW to the module.</li> </ul>
Firmware update Over The Air (FOTA)	Embedded FOTA client to enable the Firmware module update over the cellular air interface. The feature can be enabled and configured through the +UFWINSTALL AT command.
Firmware update Over AT commands (FOAT)	Firmware module update over AT command interfaces. The feature can be enabled and configured through the +UFWUPD AT command.
Network indication	GPIO configured to indicate the network status: registered home network, registered roaming, voice or data call enabled, or no service. The feature can be enabled by the +UGPIOC AT command.
Antenna detection	The <b>ANT_DET</b> pin provides antenna presence detection capability, as optional features, evaluating the resistance from <b>ANT</b> pin to GND by an external antenna detection circuit implemented on the application board. The antenna detection feature can be enabled by the +UANTR AT command.
Jamming detection	Detects “artificial” interference that obscures the operator’s carriers entitled to give access to the radio service and reports the start and stop of such conditions to the application processor that can react accordingly. The feature can be enabled and configured through the +UJAD AT command.
Embedded TCP and UDP stack	Embedded TCP/IP and UDP/IP stack including direct link mode for TCP and UDP sockets. Sockets can be set in Direct Link mode to establish a transparent end-to-end communication with an already connected TCP or UDP socket via serial interface.
Embedded FTP, FTPS	File Transfer Protocol as well as Secure File Transfer Protocol (SSL encryption of FTP control channel) functionalities are supported by AT commands.
Embedded HTTP, HTTPS (v1.0)	HyperText Transfer Protocol as well as Secure HyperText Transfer Protocol (SSL encryption) functionalities are supported via AT commands.
CoAP (RFC 7252)	Embedded Constrained Application Protocol (CoAP) datagram-based client/server application protocol designed to easily translate from HTTP for simplified integration with the web.
MQTT Anywhere	Integrated MQTT-SN client for MQTT Anywhere IoT Communication-as-a-Service support in combination with external Thingstream SIM
MQTT (v3.1) and MQTT-SN (v1.2)	Embedded Message Queuing Telemetry Transport (MQTT) and MQTT for Sensor Networks (MQTT-SN) publish-subscribe messaging protocols designed for lightweight M2M communications over TCP (MQTT) or over UDP (MQTT-SN). These protocols allow one-to-one, one-to-many and many-to-one communications over a TCP or UDP connection.
TLS and DTLS (v1.2)	Embedded Secure Sockets Layer (SSL) / Transport Layer Security (TLS) provide security for HTTP, FTP, MQTT, and TCP communications. SSL version 3.0, TLS versions 1.0, 1.1, 1.2 are supported. Embedded Datagram Transport Layer Security (DTLS) provides security for CoAP and UDP communications. DTLS version 1.2 is supported.
DNS	Support for DNS functionality.
IPv4/IPv6 dual-stack	Capability to move between IPv4 and dual stack network infrastructures. IPv4 and IPv6 addresses can be used.
PPP	IPv4/IPv6 packets relaying through the cellular protocol stack performed on a Point-to-Point Protocol (PPP) connection established with the external application via a serial interface (UART, MUX, or CDC-ACM). Transitions between Online command mode and PPP mode are supported.
Multiple PDP contexts	Multiple PDP contexts can be activated, and multi secondary PDP contexts be associated to a primary PDP context.
BIP	Bearer Independent Protocol (BIP) for Over-the-Air SIM provisioning. The data transfer to/from the SIM uses either an already active PDP context or a new PDP context established with the APN provided by the SIM card.

Feature	Description
Internal u-blox GNSS <sup>2</sup>	<p>LENA-R8001M10 modules are pre-integrated with a u-blox M10 concurrent GNSS chipset, comprehensive of a dedicated GNSS antenna interface, additional internal SAW-LNA-SAW chain for a highly reliable and accurate positioning data, plus dedicated TCXO and RTC circuit.</p> <p>The GNSS subsystem is independent from the cellular subsystem integrated in the same LENA-R8001M10 module, and it can run concurrently to a cellular modem communication. Separate supply inputs and accessible interfaces are available at module pin-out level so that the user can choose to keep the cellular system shut down when using the GNSS system.</p> <p>Access to the GNSS system over the cellular system is also possible as the two subsystems are internally interconnected by dedicated I2C interface, meaning that from any host processor a single serial port can control the cellular modem and an internal GNSS system.</p>
External u-blox GNSS control via modem <sup>3</sup>	<p>Access to external u-blox M10 positioning chips and modules over the cellular modem integrated in LENA-R8001 modules is supported through I2C interface (SDA and SCL pins). A single serial port of any host processor connected to the LENA-R8001 cellular modem can control both the cellular modem and an external u-blox M10 positioning chip or module.</p>
Embedded AssistNow software	<p>Embedded AssistNow Online and AssistNow Offline clients are available to provide better GNSS performance and faster Time-to-First-Fix.</p>
CellLocate <sup>®</sup>	<p>Enables the estimation of device position based on the parameters of the mobile network cells visible to the specific device based on the CellLocate<sup>®</sup> database.</p> <p>A set of AT commands allows CellLocate<sup>®</sup> service configuration and position request.</p> <p> u-blox is extremely mindful of user privacy. When a position is sent to the CellLocate<sup>®</sup> server, u-blox is unable to track the SIM used or the specific device.</p>
Hybrid positioning	<p>The current module position is provided by a u-blox positioning chip or module or the estimated position from CellLocate<sup>®</sup> depending on which method provides the best and fastest solution according to the user configuration.</p> <p>A set of AT commands allows Hybrid positioning service configuration and position request.</p>
Smart Temperature Supervisor	<p>Constant monitoring of the module board temperature:</p> <ul style="list-style-type: none"> <li>Warning notification when the temperature approaches an upper or lower predefined threshold</li> <li>Shutdown notified and forced when the temperature value is outside the specified range (shutdown suspended in case of an emergency call in progress)</li> </ul> <p>The optional Smart Temperature Supervisor feature is by default disabled, and it can be enabled and configured by the +USTS AT command.</p> <p> The sensor measures the board temperature, which can differ from ambient temperature.</p>
Low power idle mode	<p>The power saving configuration is disabled by default, but it can be enabled and configured using the +UPSV AT command. When the power saving is enabled, the module automatically enters the low power idle mode whenever possible, reducing current consumption.</p>
LTE cDRX	<p>Both the Long DRX Cycle and the Short DRX cycle are supported for LTE Connected Discontinuous Reception, reducing current consumption and LTE network use during periods of data inactivity.</p>

**Table 3: Main features supported by LENA-R8 series modules**

<sup>2</sup> Not available with LENA-R8001 modules

<sup>3</sup> Not available with LENA-R8001M10 modules

## 2 Cellular subsystem interfaces

### 2.1 Cellular power management

#### 2.1.1 Cellular supply input (VCC)

The cellular subsystem of the LENA-R8 series modules must be supplied through the three **VCC** pins by a DC power supply. Voltage must be stable, because during operation the current drawn from **VCC** can vary by some order of magnitude, especially due to the surging consumption profile of the GSM system (described in LENA-R8 series system integration manual [2]). It is important that the system power supply circuit can support peak power.

LENA-R8 series modules provide separate supply inputs over the three **VCC** pins:

- **VCC** pins #52 and #53 represent the supply input for the internal cellular RF power amplifiers, demanding most of the total current drawn by the module when RF transmission is enabled
- **VCC** pin #51 represents the supply input for the internal cellular Power Management Unit and the internal cellular transceiver, demanding a minor part of the total current drawn by the module when cellular RF transmission is enabled

#### 2.1.2 Cellular RTC supply input / output (V\_BCKP)

When **VCC** voltage is within the valid operating range, the internal Power Management Unit (PMU) supplies the Real Time Clock (RTC) of the LENA-R8 series modules' cellular subsystem, and the same supply voltage is available on the **V\_BCKP** pin. If the **VCC** voltage is under the minimum operating limit (e.g. during not powered mode), the **V\_BCKP** pin can externally supply the RTC of the cellular system.

#### 2.1.3 Cellular generic digital interfaces supply output (V\_INT)

LENA-R8 series modules provide a 1.8 V supply rail output on the **V\_INT** pin, which is internally generated when the cellular subsystem is switched on. The same voltage domain is used internally to supply the generic digital interfaces of the cellular subsystem (as the UARTs, I2C, I2S, GPIOs). The **V\_INT** supply output can be used in place of an external discrete regulator.



It is recommended to provide accessible test point directly connected to the **V\_INT** input pin.

### 2.2 Cellular antenna interface

#### 2.2.1 Cellular antenna RF interface (ANT)

The **ANT** pin is the cellular RF antenna I/O interface, designed with 50  $\Omega$  characteristic impedance for the transmission and reception of LTE Cat 1bis and/or 2G radio frequency signals.

#### 2.2.2 Cellular antenna detection (ANT\_DET)

The **ANT\_DET** pin is an Analog to Digital Converter (ADC) input with a current source provided by LENA-R8 series modules to sense the external cellular antenna presence (as an optional feature). It evaluates the resistance from **ANT** pin to GND by an external antenna detection circuit implemented on the application board. For more details, see the LENA-R8 series system integration manual [2].

#### 2.2.3 Cellular antenna dynamic tuner interface



Cellular antenna dynamic tuner interface (**RFCTRL1** and **RFCTRL2** pins) is not supported.

LENA-R8 series modules' cellular system includes 2 output pins (**RFCTRL1** / **RFCTRL2**) for real time control of an external antenna tuning IC according to the actual cellular band used by the module.

## 2.3 Cellular system functions

### 2.3.1 Cellular system power-on

When the cellular system of the modules is not powered, it can be switched on as follows:

- Apply a voltage at the **VCC** cellular supply input within the operating range (see [Table 9](#)), then wait at least 1.5 s, and then force a low level at the **PWR\_ON** input pin, which is normally set high by an internal pull-up, for a valid time period (see section [5.2.9](#), module cellular system switch on).

When module's cellular system is in power-off mode (switched off, with a voltage at the **VCC** cellular supply input within the normal operating range reported in [Table 9](#)), it can be switched on as follows:

- Force a low level at the **PWR\_ON** input pin, which is normally set high by an internal pull-up, for a valid time period (see section [5.2.9](#), module switch on).
- RTC alarm, i.e. pre-programmed scheduled time by AT+CALA command.

The **PWR\_ON** input line is intended to be driven by open drain, open collector, or contact switch.

 It is recommended to provide accessible test point directly connected to the **PWR\_ON** input pin.

### 2.3.2 Cellular system power-off

The modules' cellular system can be properly switched off, with storage of the current parameter settings in the internal non-volatile memory and a clean network detach, in one of these ways:

- AT+CPWROFF command (see the AT commands manual [\[1\]](#)).
- Forcing a low pulse at the **PWR\_ON** input pin, which is normally set high by an internal pull-up, for a valid time period (see section [5.2.9](#)). The **PWR\_ON** input line is intended to be driven by open drain, open collector or contact switch.

An abrupt shutdown occurs on LENA-R8 series modules' cellular system, without storage of the current parameter settings and without a clean network detach, when the VCC cellular system supply drops below the extended operating range minimum limit.

An over-temperature or an under-temperature shutdown occurs on LENA-R8 series modules' cellular system when the temperature measured within the cellular module reaches the dangerous area, if the optional Smart Temperature Supervisor feature is enabled and configured by +USTS AT command. For more details, see section [5.2.15](#) and the AT commands manual [\[1\]](#).

### 2.3.3 Cellular system reset

LENA-R8 series modules' cellular system can be reset (rebooted), with storage of current parameter settings in the internal non-volatile memory and a clean network detach, by:

- AT+CFUN=16 command (see the AT commands manual [\[1\]](#) for detailed description and other options). This causes an "internal" or "software" reset of the module.

An abrupt hardware reset occurs on LENA-R8 series modules' cellular system, without storage of the current parameter settings and without a clean network detach, when:

- a low level is forced at the **RESET\_N** input pin, which is normally set high by an internal pull-up, for a valid time period (see section [5.2.10](#), cellular system abrupt reset).

The **RESET\_N** input line is intended to be driven by open drain, open collector, or contact switch.

 It is recommended to provide accessible test point directly connected to the **RESET\_N** input pin.

## 2.4 Cellular SIM interface

### 2.4.1 Cellular SIM card / chip interface

LENA-R8 series modules' cellular system includes an interface to connect an external SIM card / chip over the **VSIM**, **SIM\_IO**, **SIM\_CLK**, **SIM\_RST** pins: the high-speed SIM/ME interface is implemented as well as the automatic detection of the required SIM supporting voltage.

Both 1.8 V and 3.0 V SIM types are supported (1.8 V and 3.0 V ME). Activation and deactivation with automatic voltage switch from 1.8 V to 3.0 V is implemented, according to ISO-IEC 7816-3 specs.

## 2.5 Cellular serial communication interfaces

LENA-R8 series modules' cellular system provides the following serial communication interfaces:

- Main UART: serial interface available for the communication with a host application processor (AT & data communication, multiplexer functionality, FW update by FOAT).
- Auxiliary UART<sup>4</sup>: serial interface available for communication with a host application processor (AT & data communication, GNSS data tunneling).
- USB: Universal Serial Bus 2.0 interface available for the communication with a host application processor (AT commands, data communication, GNSS data tunneling, FW update by FOAT), for FW update by dedicated tool, and for diagnostic.
- I2C interface<sup>5</sup>: I2C-bus compatible interface available for communication with compatible external u-blox M10 positioning chips / modules.

### 2.5.1 Cellular UART interfaces

#### 2.5.1.1 Cellular main UART interface

The modules' cellular system includes a main **UART** serial interface for communication with an external host processor, supporting AT commands, data communication, multiplexer protocol functionality, and FW update by FOAT:

- 8-wire serial port with RS-232 functionality conforming to ITU-T V.24 recommendation [12], with CMOS compatible levels (0 V for low data bit / ON state, 1.8 V for high data bit / OFF state)
  - Data lines (**RXD** output, **TXD** input),
  - hardware flow control lines (**CTS** output, **RTS** input),
  - modem status and control lines (**DTR** input, **DSR** output, **DCD** output, **RI** output)
- One-shot autobauding is supported and is enabled by default: automatic baud rate detection is performed only once, at module start up. When autobauding is enabled, the first AT command sent to the module is not processed, because it is used by the module to detect the baud rate. After the detection, the module works at the detected baud rate, which can be changed via the +IPR AT command.
- 115,200 bit/s, 230,400 bit/s, 460,800 bit/s, 921,600 bit/s baud rates are supported
- 8N1 (default value: 8 data bits, no parity, 1 stop bit), 8N2 and 8E1 frame formats are supported

The UART serial interface can be conveniently configured through dedicated AT commands: see the u-blox AT commands manual [1] (+IPR, +ICF, +IFC, &K, &S, &D, &C AT commands).

<sup>4</sup> The support of the auxiliary UART interface is not presented with the "00C" product version of LENA-R8 modules

<sup>5</sup> The support of the cellular external I2C interface is not presented with the "00C" product version of LENA-R8001M10 modules

### 2.5.1.2 Cellular auxiliary UART interface

 The support of the cellular auxiliary UART interface is not presented with the “00C” product version of LENA-R8 series modules.

The modules’ cellular system includes an auxiliary **UART AUX** interface for communication with external host processor, for AT commands, data communication, GNSS data tunneling:

- 4-wire serial port with RS-232 functionality conforming to ITU-T V.24 recommendation [12], with CMOS compatible signal levels (0 V for low data bit / ON state, 1.8 V for high data bit / OFF state)
  - Data lines (**DCD** as data output, **DTR** as data input)
  - HW flow control lines (**RI** as flow control output, **DSR** as flow control input)

### 2.5.1.3 Multiplexer protocol

The modules’ cellular system includes multiplexer functionality as per 3GPP TS 27.010 [9] only on the main **UART** physical interface.

The multiplexer functionality is a data link protocol which uses HDLC-like framing and operates between the module (DCE) and the application processor (DTE), allowing several simultaneous sessions over the physical link, which is the main **UART** physical interface: the user can concurrently use AT interface on one MUX channel and data communication on another MUX channel.

## 2.5.2 Cellular USB interface

LENA-R8 series modules’ cellular system includes a USB High-Speed 2.0 compliant interface with a maximum 480 Mbit/s data rate according to the Universal Serial Bus specification revision 2.0 [13]. The module itself acts as a USB device and can be connected to any compatible USB host.

The interface is available for communication with external host application processor (AT commands, data, FW update by means of FOAT), for FW update by means of dedicated tool, and for diagnostics.

The **USB\_D+** / **USB\_D-** lines carry the USB data and signaling. The USB interface is enabled if an external valid USB VBUS voltage applied on the **VUSB\_DET** input pin of the module.

The USB interface of LENA-R8 series cellular system may enable the following USB functions:

- Three virtual serial ports over USB for AT commands and data communication
- One virtual serial port over USB for GNSS data tunneling
- One virtual serial port over USB for Diagnostic log
- RNDIS for Ethernet-over-USB
- CDC-ECM for Ethernet-over-USB

For more details about USB, see the LENA-R8 series system integration manual [2].

LENA-R8 series modules are compatible with the standard Linux/Android USB kernel drivers.

 The **USB\_BOOT** input pin must be set high, at the 1.8 V voltage level of the **V\_INT** supply output, to enable the FW update by the dedicated tool over the USB interface of the LENA-R8 series modules’ cellular system. Only if the **USB\_BOOT** pin is left floating (unconnected), or it is set low (grounded), LENA-R8 series modules’ cellular system can boot in normal operating mode.

 It is highly recommended to provide access to the **VUSB\_DET**, **USB\_D+**, **USB\_D-** and **USB\_BOOT** pins of LENA-R8 series modules’ cellular system for FW update and for diagnostic purpose, by means of test points directly connected to the pins.

### 2.5.3 Cellular I2C interface

 The support of the cellular I2C interface over **SDA** and **SCL** pins is not presented with the “00C” product version of the LENA-R8001M10 modules.

LENA-R8001 modules include an I2C-bus compatible interface over the **SDA** and **SCL** pins available to communicate with external u-blox M10 GNSS chips / modules: the LENA-R8001 module acts as an I2C host which can communicate with I2C devices in accordance with the I2C bus specifications [14].

## 2.6 Cellular audio interface

 The support of the cellular I2S digital audio interface function over **I2S\_TXD**, **I2S\_RXD**, **I2S\_CLK** and **I2S\_WA** pins is not presented with the “00C” product version of LENA-R8 series modules.

## 2.7 Cellular clock output

 The support of the cellular clock output functionality over the **GPIO6** pin is not presented with the “00C” product version of LENA-R8 series modules.

## 2.8 Cellular GPIO pins

LENA-R8 series modules’ cellular system includes 6 pins (**GPIO1-GPIO6**) that can be configured as General Purpose Input/Output or to provide custom functions as summarized in the [Table 4](#) (for further details, see the GPIO section in the AT commands manual [1]).

Function	Description	Default GPIO	Configurable GPIOs
Network status indication	Network status: registered home network, registered roaming, data transmission, no service	--	GPIO1, GPIO2, GPIO3, GPIO4
GNSS supply enable	Enable/disable the supply of the u-blox GNSS receiver connected to the cellular system	--	GPIO1, GPIO2, GPIO3, GPIO4
GNSS data ready <sup>6</sup>	Sense when the external u-blox GNSS system connected to the cellular system is ready to send data by I2C	--	GPIO3
General purpose input	Input to sense high or low digital level	--	All
General purpose output	Output to set the high or the low digital level	--	All
Pin disabled	Tri-state with an internal active pull-down enabled	All	All

**Table 4: GPIO custom functions configuration**

## 2.9 Reserved pins

LENA-R8 series modules include pins reserved for possible future use, marked as **RSVD**, which can all be left unconnected on the application board.

<sup>6</sup> LENA-R8001 only

## 3 GNSS subsystem interfaces

 The GNSS subsystem is not available with LENA-R8001 modules.

### 3.1 GNSS power management

#### 3.1.1 GNSS supply input (VCC\_GNSS)

The **VCC\_GNSS** pin is the main supply input for the GNSS system integrated in LENA-R8001M10 modules, providing power to the GNSS RF domains and internal LNA, the GNSS system core, the GNSS digital peripheral I/O, the dedicated TCXO through an integrated LDO regulator, as is illustrated in [Figure 2](#).

Connecting an external DC power supply at the **VCC\_GNSS** input is necessary for normal operations. Voltage must be clean, stable, and tight at 1.8 V to properly supply the system with related parts.

During operation, the current drawn by the GNSS system may vary. For this reason, it is important that the supply circuitry is able to support the peak power for a short time.

For more information about GNSS supply input, see the u-blox M10 standard precision GNSS chip data sheet [\[3\]](#) and integration manual [\[4\]](#).

#### 3.1.2 GNSS backup supply input (VBCKP\_GNSS)

The **VBCKP\_GNSS** pin is the backup supply input for the GNSS system of the LENA-R8001M10 modules, designed to keep the GNSS backup RAM memory and the GNSS RTC alive in case of voltage interruption at the main **VCC\_GNSS** input pin.

Connecting an external DC power supply at the **VBCKP\_GNSS** input is optional. If present, it enables the hardware backup mode when the main **VCC\_GNSS** supply is not present.

For more information about GNSS backup supply input, see the u-blox M10 standard precision GNSS chip data sheet [\[3\]](#) and integration manual [\[4\]](#).

### 3.2 GNSS antenna interface

#### 3.2.1 GNSS antenna RF interface (ANT\_GNSS)

The **ANT\_GNSS** pin represents the GNSS RF input of the LENA-R8001M10 modules, designed with 50  $\Omega$  characteristic impedance and with an internal DC block, suitable for both active and/or passive GNSS antennas due to the built-in SAW filter followed by an LNA followed by another SAW filter in front of the integrated high performing u-blox M10 concurrent GNSS engine.

For more information about GNSS RF capabilities, see the u-blox M10 standard precision GNSS chip data sheet [\[3\]](#) and integration manual [\[4\]](#).

#### 3.2.2 GNSS LNA or antenna on/off control (ANT\_ON)

The **ANT\_ON** output pin of LENA-R8001M10 modules is a 1.8 V peripheral output pin of the internal u-blox M10 GNSS chipset, available to provide optional control for switching on/off the power supply to an external active GNSS antenna or an external separate LNA as it controls at the same time the internal LNA integrated in the module. This facility is provided to help minimize power consumption in power save mode operation.



## 3.3 GNSS serial communication interface

### 3.3.1 GNSS UART interface

LENA-R8001M10 modules supports a 1.8 V Universal Asynchronous Receiver/Transmitter (UART) interface consisting of the **RXD\_GNSS** data input line and the **TXD\_GNSS** data output line, directly connected to the internal u-blox M10 GNSS chipset, as is illustrated in [Figure 2](#).

The GNSS UART can be used as serial interface for direct communication between the internal u-blox M10 GNSS chipset and an external host.

The GNSS UART interface supports configurable baud rates. The default baud rate is 38,400 bit/s, with 8N1 (8 data bits, no parity, 1 stop bit) default frame format.

Neither handshaking signals nor hardware flow control signals are available in the UART interface.

For more information about GNSS UART interface, see the u-blox M10 standard precision GNSS chip data sheet [\[3\]](#), integration manual [\[4\]](#), and interface description [\[5\]](#).

 It is recommended to provide access to the **RXD\_GNSS** and **TXD\_GNSS** pins of LENA-R8001M10 modules for diagnostic purpose, by test points directly connected to the pins.

## 3.4 GNSS peripheral input/output

LENA-R8001M10 modules provide the following 1.8 V peripheral output pins directly connected to the internal u-blox M10 GNSS chipset, as is illustrated in [Figure 2](#):

- The **TIMEPULSE** output pin features time pulse signal. Make sure there is no load at this pin, which could cause the pin being low at startup.
- The **EXTINT** external interrupt input pin, which can be used for functions such as accurate external frequency aiding, time mark aiding, wake up from power save mode, and ON/OFF control of the GNSS receiver.

For more information about GNSS peripheral input/output, see the u-blox M10 standard precision GNSS chip data sheet [\[3\]](#), integration manual [\[4\]](#), and interface description [\[5\]](#).



No	Name	Power domain	I/O	Description	Remarks
6	DSR	GDI	O/ I	Cellular UART data set ready / AUX UART request to send <sup>7</sup>	UART Circuit 107 in ITU-T V.24 (DSR output, push-pull, idle high, active low), alternatively configurable as AUX UART RTS (HW flow control input, idle high, active low, with internal active pull-up) <sup>7</sup> . See section 5.2.14 for detailed electrical specs.
7	RI	GDI	O/ O	Cellular UART ring indicator / AUX UART clear to send <sup>7</sup>	UART Circuit 125 in ITU-T V.24 (RI output, push-pull, idle high, active low), alternatively configurable as AUX UART CTS (HW flow control output, push-pull, idle high, active low) <sup>7</sup> . See section 5.2.14 for detailed electrical specs.
8	DCD	GDI	O/ O	Cellular UART data carrier detect / AUX UART data output <sup>7</sup>	UART Circuit 109 in ITU-T V.24 (DCD output, push-pull, idle high, active low), alternatively configurable as AUX UART RXD (data output, push-pull, idle high, active low) <sup>7</sup> . See section 5.2.14 for detailed electrical specs.
9	DTR	GDI	I/ I	Cellular UART data terminal ready / AUX UART data input <sup>7</sup>	UART Circuit 108/2 in ITU-T V. 24 (DTR input, idle high, active low, with internal active pull-up enabled), alternatively settable as AUX UART TXD (data input, idle high, active low, with internal active pull-up) <sup>7</sup> . See section 5.2.14 for detailed electrical specs.
10	RTS	GDI	I	Cellular UART ready to send	UART Circuit 105 in ITU-T V.24 (RTS flow control input, idle high, active low, with internal active pull-up). See section 5.2.14 for detailed electrical specs.
11	CTS	GDI	O	Cellular UART clear to send	UART Circuit 106 in ITU-T V.24 (CTS hardware flow control output, push-pull, idle high, active low). See section 5.2.14 for detailed electrical specs.
12	TXD	GDI	I	Cellular UART data input	UART Circuit 103 in ITU-T V.24 (Tx data input, idle high, active low, with internal active pull-up). See section 5.2.14 for detailed electrical specs.
13	RXD	GDI	O	Cellular UART data output	UART Circuit 104 in ITU-T V.24 (Rx data output, push-pull, idle high, active low). See section 5.2.14 for detailed electrical specs.
14	GND	-	N/A	Ground	All GND pins are intended to be connected to ground
15	PWR_ON	POS	I	Cellular Power-on input	Internal 20 kΩ pull-up to VCC. Active low. See section 5.2.9 for detailed electrical specs. Provide test point for diagnostic purposes.
16	GPIO1	GDI	I/O	Cellular GPIO	GPIO configurable as described in section 2.8. Push-pull output type. See section 5.2.14 for detailed electrical specs.
17	VUSB_DET	VBUS	I	Cellular VBUS USB detect input	VBUS 5 V typical voltage must be connected to this input pin to enable the cellular USB interface. See section 5.2.12 for detailed electrical specs. Provide test point for diagnostic purposes.
18	RESET_N	ERS	I	External reset input	Internal 20 kΩ pull-up to VCC. Active low. See section 5.2.10 for detailed electrical specs. Provide test point for diagnostic purposes.
19	GPIO6	GDI	I/O	Cellular GPIO	GPIO configurable as described in section 2.8. Push-pull output type. See section 5.2.14 for detailed electrical specs.
20	GND	-	N/A	Ground	All GND pins are intended to be connected to ground
21	RSVD	-	N/A	RESERVED pin	Pin reserved for possible future use.
22	GND	-	N/A	Ground	All GND pins are intended to be connected to ground

<sup>7</sup> The support of the cellular auxiliary UART interface is not presented with the “OOC” product version of LENA-R8 modules

No	Name	Power domain	I/O	Description	Remarks
23	GPIO2	GDI	I/O	Cellular GPIO	GPIO configurable as described in section 2.8. Push-pull output type. See section 5.2.14 for detailed electrical specs.
24	GPIO3	GDI	I/O	Cellular GPIO	GPIO configurable as described in section 2.8. Push-pull output type. See section 5.2.14 for detailed electrical specs.
25	GPIO4	GDI	I/O	Cellular GPIO	GPIO configurable as described in section 2.8. Push-pull output type. See section 5.2.14 for detailed electrical specs.
26	SDA	I2C	I/O	Cellular I2C bus data line	I2C is not supported by LENA-R8001M10-00C. Open drain output type. Active low. Internal 20 k $\Omega$ active pull-up to V_INT. See section 5.2.13 for detailed electrical specs.
27	SCL	I2C	O	Cellular I2C bus clock line	I2C is not supported by LENA-R8001M10-00C. Open drain output type. Active low. Internal 20 k $\Omega$ active pull-up to V_INT. See section 5.2.13 for detailed electrical specs.
28	USB_D-	USB	I/O	Cellular USB Data Line D-	90 $\Omega$ nominal differential characteristic impedance. Pull-up, pull-down and series resistors as required by the USB 2.0 specifications [13] are part of the USB pin driver and need not be provided externally. See section 5.2.12 for detailed electrical specs. Provide test point for diagnostic purposes.
29	USB_D+	USB	I/O	Cellular USB Data Line D+	90 $\Omega$ nominal differential characteristic impedance. Pull-up, pull-down and series resistors as required by the USB 2.0 specifications [13] are part of the USB pin driver and need not be provided externally. See section 5.2.12 for detailed electrical specs. Provide test point for diagnostic purposes.
30	GND	-	N/A	Ground	All GND pins are intended to be connected to ground
31	ANT_GNSS	-	I	GNSS RF antenna	LENA-R8001M10 only. RF input for GNSS Rx antenna. 50 $\Omega$ nominal impedance. See section 3.2.1 and Table 2 for description. Internally not connected on LENA-R8001.
32	GND	-	N/A	Ground	All GND pins are intended to be connected to ground
33	USB_BOOT	GDI	I	Cellular USB boot	Input to force FW update over cellular USB. Provide test point for diagnostic purposes.
34	I2S_WA	GDI	I	Cellular I2S word alignment	I2S interface function is currently not presented. I2S word alignment frame synchronization signal. See section 5.2.14 for detailed electrical specs.
35	I2S_TXD	GDI	O	Cellular I2S transmit data	I2S interface function is currently not presented. I2S data output. Push-pull output type. See section 5.2.14 for detailed electrical specs.
36	I2S_CLK	GDI	I	Cellular I2S clock	I2S interface function is currently not presented. I2S clock. See section 5.2.14 for detailed electrical specs.
37	I2S_RXD	GDI	I	Cellular I2S receive data	I2S interface function is currently not presented. I2S data input. See section 5.2.14 for detailed electrical specs.
38	SIM_CLK	SIM	O	Cellular SIM clock	See section 5.2.10 for detailed electrical specs.
39	SIM_IO	SIM	I/O	Cellular SIM data	Internal 4.7 k $\Omega$ pull-up resistor to VSIM. See section 5.2.10 for detailed electrical specs.

No	Name	Power domain	I/O	Description	Remarks
40	SIM_RST	SIM	O	Cellular SIM reset	See section 5.2.10 for detailed electrical specs.
41	VSIM	SIM	O	Cellular SIM supply output	VSIM = 1.80 V or 3.0 V typical generated by the module according to the external SIM card/chip type. See section 5.2.2 for detailed electrical specs.
42	GPIO5	GDI	I/O	Cellular GPIO	GPIO configurable as described in section 2.8. Push-pull output type. See section 5.2.14 for detailed electrical specs.
43	GND	-	N/A	Ground	All GND pins are intended to be connected to ground
44	ANT_ON	GNSS	O	GNSS antenna enable	LENA-R8001M10 only. GNSS peripheral with external GNSS active antenna control and/or external LNA on/off control function, connected to internal LNA. Push-pull output type. See section 5.2.16 for detailed electrical specs. Internally not connected on LENA-R8001.
45	TIMEPULSE	GNSS	O	GNSS time pulse	LENA-R8001M10 only. GNSS peripheral with time pulse output function. Push-pull output type. See section 5.2.16 for detailed electrical specs. Internally not connected on LENA-R8001.
46	EXTINT	GNSS	I	GNSS external interrupt	LENA-R8001M10 only. GNSS peripheral with external interrupt input function. See section 5.2.16 for detailed electrical specs. Internally not connected on LENA-R8001.
47	TXD_GNSS	GNSS	O	GNSS UART data output	LENA-R8001M10 only. GNSS UART data output. Push-pull output type. See section 5.2.16 for detailed electrical specs. Internally not connected on LENA-R8001.
48	RXD_GNSS	GNSS	I	GNSS UART data input	LENA-R8001M10 only. GNSS UART data input. See section 5.2.16 for detailed electrical specs. Internally not connected on LENA-R8001.
49	RSVD	-	N/A	RESERVED pin	Pin reserved for possible future use.
50	GND	-	N/A	Ground	All GND pins are intended to be connected to ground
51	VCC	-	I	Cellular supply input	Supply input for cellular Power Management Unit part. All VCC pins must be connected to external supply. See sections 5.2.2 and 5.2.3 for detailed specs.
52	VCC	-	I	Cellular supply input	Supply for cellular RF Power Amplifiers part. All VCC pins must be connected to external supply. See sections 5.2.2 and 5.2.3 for detailed specs.
53	VCC	-	I	Cellular supply input	Supply for cellular RF Power Amplifiers part. All VCC pins must be connected to external supply. See sections 5.2.2 and 5.2.3 for detailed specs.
54	GND	-	N/A	Ground	All GND pins are intended to be connected to ground
55	GND	-	N/A	Ground	All GND pins are intended to be connected to ground
56	ANT	-	I/O	Cellular RF antenna	RF input/output for Cellular Rx/Tx antenna. 50 Ω nominal characteristic impedance. See section 5.2.6 and 5.2.7 for details.
57	GND	GND	N/A	Ground	All GND pins are intended to be connected to ground
58	GND	GND	N/A	Ground	All GND pins are intended to be connected to ground



No	Name	Power domain	I/O	Description	Remarks
59	ANT_DET	ADC	I	Cellular antenna detection	ADC input for cellular antenna presence detection. See section 5.2.8 for detailed electrical specs.
60	GND	GND	N/A	Ground	All GND pins are intended to be connected to ground
61	GND	GND	N/A	Ground	All GND pins are intended to be connected to ground
62	RSVD	-	N/A	RESERVED pin	Pin reserved for possible future use
63	GND	-	N/A	Ground	All GND pins are intended to be connected to ground
64	GND	-	N/A	Ground	All GND pins are intended to be connected to ground
65-96	GND	-	N/A	Ground	All GND pins are intended to be connected to ground
97	RFCTRL1	GDI	O	RF control output	1.8 V push-pull output to dynamically control external RF antenna tuning IC, changing the high/low state in real time according to the cellular RF band in use. Function not supported. See section 5.2.14 for detailed electrical specs.
98	RFCTRL2	GDI	O	RF control output	1.8 V push-pull output to dynamically control external RF antenna tuning IC, changing the high/low state in real time according to the cellular RF band in use. Function not supported. See section 5.2.14 for detailed electrical specs.
99	VCC_GNSS	GNSS	I	GNSS supply input	LENA-R8001M10 only. GNSS supply input. See section 5.2.2 for detailed electrical specs. Internally not connected on LENA-R8001.
100	VBCKP_GNSS	-	I	GNSS backup supply input	LENA-R8001M10 only. GNSS backup supply input. See section 5.2.2 for detailed electrical specs. Internally not connected on LENA-R8001.

**Table 5: LENA-R8 series pin-out**

 For more information about the pin-out, see the LENA-R8 series system integration manual [2].

 See appendix A for an explanation of the abbreviations and terms used.

## 5 Electrical specifications

-  Stressing the device above one or more of the ratings listed in the Absolute Maximum Rating section may cause permanent damage. These are stress ratings only. Operating the module at these or at any conditions other than those specified in the Operating Conditions sections (section 5.2) of the specification should be avoided. Exposure to Absolute Maximum Rating conditions for extended periods may affect device reliability.
-  Electrical characteristics are defined according to the verification on a representative number of samples or according to the simulation.
-  Where application information is given, it is advisory only and does not form part of specification.

### 5.1 Absolute maximum rating

-  Limit values given below are in accordance with the Absolute Maximum Rating System (IEC 134).

Symbol	Parameter	Min.	Max.	Unit
VCC	Input voltage at cellular supply VCC pins	-0.3	5.5	V
V_BCKP	Input voltage at cellular RTC supply V_BCKP pin	-0.3	5.5	V
VUSB_DET	Input voltage at cellular USB detection VUSB_DET pin	-0.3	5.5	V
USB	Input voltage at cellular USB_D+ and USB_D- pins	-0.3	3.6	V
GDI	Input voltage at cellular Generic Digital Interfaces pins	-0.3	2.1	V
I2C	Input voltage at cellular I2C interface pins	-0.3	2.1	V
SIM	Input voltage at cellular SIM interface pins	-0.3	3.6	V
ERS	Input voltage at cellular External Reset Signal RESET_N pin	-0.3	5.5	V
POS	Input voltage at cellular Power-on Signal PWR_ON pin	-0.3	5.5	V
ADC	Input voltage at cellular antenna detection ANT_DET pin	-0.3	2.1	V
Rho_ANT	Output RF load mismatch ruggedness at cellular ANT pin		10:1	VSWR
P_ANT	Input RF power at cellular antenna ANT pin		3	dBm
	Input RF power at GNSS antenna ANT_GNSS pin		10	dBm
	Input RF power at GNSS antenna ANT_GNSS pin <sup>8</sup>		15	dBm
	Input RF power at GNSS antenna ANT_GNSS pin <sup>9</sup>		25	dBm
VCC_GNSS	Input voltage at GNSS supply VCC_GNSS pin	-0.3	1.98	V
	Input voltage ramp at GNSS supply VCC_GNSS pin	25	35000	μs/V
VBCKP_GNSS	Input voltage at GNSS backup supply VBCKP_GNSS pin	-0.3	3.6	V
	Input voltage ramp at GNSS backup supply VBCKP_GNSS pin	25		μs/V
GNSS	Input voltage at GNSS peripherals I/O pins	-0.3	VCC_GNSS + 0.3 V (max 1.98)	V
Tstg	Storage Temperature	-40	+85	°C

**Table 6: Absolute maximum ratings**

-  The product is not protected against overvoltage or reversed voltages. If necessary, voltage spikes exceeding the power supply voltage specification, given in the table above, must be limited to values within the specified boundaries by using appropriate protection devices.

<sup>8</sup> Applicable for LTE OFDM signals in the frequency ranges 617-915 MHz, 1427-1510.9 MHz, 1710-2690 MHz, 3300-5000 MHz.

<sup>9</sup> Applicable for GSM duty cycle 1:8 in the frequency ranges 824-894 MHz, 880-915 MHz, 1710-1785 MHz, 1850-1910 MHz.

### 5.1.1 Maximum ESD

Parameter	Min.	Max.	Unit	Remarks
ESD sensitivity for all pins		1000	V	Human Body Model according to JS-001-2017
		500	V	Charged Device Model according to JS-002-2018

Table 7: Maximum ESD ratings

The modules are Electrostatic Sensitive Devices and require special precautions when handling.

## 5.2 Operating conditions

Unless otherwise indicated, all operating condition specifications are at +25 °C temperature.

Operation beyond the operating conditions is not recommended and extended exposure beyond them may affect device reliability.

### 5.2.1 Operating temperature range

Parameter	Min.	Typical	Max.	Unit	Remarks
Normal operating temperature	-20	+25	+65	°C	Operating within 3GPP / ETSI specifications
Extended operating temperature	-40		+85	°C	Operating with possible slight deviation in RF performance outside normal operating range

Table 8: Environmental conditions

### 5.2.2 Supply/power pins

Symbol	Parameter	Min.	Typical	Max.	Unit
VCC	Normal operating input voltage for cellular supply pins 51, 52, 53 <sup>10</sup>	3.40	3.80	4.20	V
	Extended operating input voltage for cellular supply pin 51 <sup>11</sup>	3.20	3.80	4.50	V
	Extended operating input voltage for cellular supply pins 52, 53 <sup>12</sup>	3.00	3.80	4.50	V
V_BCKP	Operating input voltage for cellular RTC supply	2.80	3.00	3.20	V
	Indicative current consumption for cellular RTC with V_BCKP = 3 V		2		µA
VCC_GNSS	Operating input voltage for GNSS supply	1.78	1.80	1.85	V
VBCKP_GNSS	Operating input voltage for GNSS backup supply	1.78	1.80	3.60	V

Table 9: Input characteristics of the Supply/Power pins

Symbol	Parameter	Min.	Typical	Max.	Unit
VSIM	Cellular SIM supply output voltage, with external 1.8 V SIM		1.8		V
	Cellular SIM supply output voltage, with external 3.0 V SIM		3.0		V
V_INT	Cellular Generic Digital Interfaces supply output voltage		1.8		V
	Cellular Generic Digital Interfaces supply output current capability			70	mA
V_BCKP	Cellular RTC supply output voltage		3.0		V
	Cellular RTC supply output current capability			2	mA

Table 10: Output characteristics of the Supply/Power pins

<sup>10</sup> Operating within 3GPP / ETSI specifications.

<sup>11</sup> The voltage has to be above the extended operating range minimum limit for the **VCC** pin 51 (supply input for the baseband Power Management Unit and the Transceiver) to switch-on the module and to avoid possible switch-off of the module.

<sup>12</sup> Operating with possible slight deviation in RF performance outside normal operating range. The Power Amplifier may not be fully functional when the voltage drops below the extended operating range minimum limit defined for the **VCC** pins 52 and 53 (supply input for the internal Power Amplifier).



### 5.2.3 Cellular current consumption

Mode	Condition	Tx power	Min	Typ <sup>13</sup>	Max <sup>14</sup>	Unit
Power-off mode	Averaged current value Module gracefully switched off			3		µA
Cyclic Idle/Active-Mode (Low power mode enabled by +UPSV, Module registered with network)	Averaged current value, Idle mode floor current, USB not connected			1.2		mA
	Averaged current value, Idle mode floor current, USB suspended			3.2		mA
	Averaged current value, Cyclic DRX = 2.56 s, USB not connected			1.5		mA
	Averaged current value, Cyclic DRX = 2.56 s, USB suspended			3.5		mA
Active-Mode (Low power mode disabled by +UPSV, Module registered with network)	Averaged current value, Cyclic DRX = 2.56 s, USB not connected			13		mA
	Averaged current value, Cyclic DRX = 2.56 s, USB in use			29		mA
2G Connected Mode (Tx / Rx call enabled)	Peak value at 1-slot GMSK Tx burst, 900 MHz band	Maximum		1.5	1.9	A
	Averaged value along 1-slot GMSK call, 900 MHz band	Minimum		70		mA
		Maximum		280		mA
	Averaged value along 1-slot GMSK call, 1800 MHz band	Minimum		60		mA
Maximum			160		mA	
LTE Connected Mode (Tx / Rx enabled)	Averaged value along LTE-FDD Tx / Rx	Minimum		130		mA
		0 dBm		140		mA
		12 dBm		230		mA
		18 dBm		370		mA
		Maximum		590		mA

Table 11: LENA-R8 series cellular VCC current consumption

Parameter	Min	Typ	Max	Unit
Current consumption through the VCC pin #51 (supply input for cellular PMU and transceiver)			300	mA

Table 12: LENA-R8 series cellular VCC pin #51 current consumption

### 5.2.4 GNSS current consumption

Parameter	Condition	GPS	GPS+GAL	GPS+GAL +GLO	GPS+GAL +BDS B1I	GPS+GAL +BDS B1C	GPS+GAL +BDS B1C +GLO	Unit	
VCC_GNSS	Peak current	Acquisition	100	100	100	100	100	mA	
	Average current	Acquisition	26	32	37	36.5	35	39	mA
		Continuous tracking	23.5	24.5	28	29	27.5	30	mA
		Cyclic tracking <sup>15</sup>	16	17	18	18	-	-	mA

Table 13: LENA-R8001M10 GNSS supply indicative current consumption with VCC\_GNSS = 1.8 V

Parameter	Condition	Typ.	Unit
VBCKP_GNSS	Backup current in hardware backup mode VBCKP_GNSS = 1.8 V / VCC_GNSS = 0 V	25	µA

Table 14: LENA-R8001M10 GNSS backup supply indicative current consumption

<sup>13</sup> Typical values with a matched antenna

<sup>14</sup> Maximum values with a mismatched antenna

<sup>15</sup> Cyclic tracking power save mode with update period 1 s. Not supported with GNSS configurations that include BeiDou B1C

## 5.2.5 GNSS characteristics and performances

Parameter	Specification	
Receiver type	u-blox UBX-M10050-KB-A0100A SPG 5.10, supporting concurrent reception of up to 4 GNSS	
GNSS systems	GPS / QZSS	L1C/A (1575.42 MHz)
	Galileo	E1B/C (1575.42 MHz)
	GLONASS	L1OF (1602 MHz + k*562.5 kHz, k = -7,..., 5, 6)
	BeiDou <sup>16</sup>	B1I (1561.098 MHz), B1C (1575.42 MHz)
Augmentation systems	SBAS	EGNOS, GAGAN, MSAS and WAAS
	QZSS	L1S (SLAS)
Operational limits <sup>17</sup>	Dynamics	≤ 4 g
	Altitude	80'000 m
	Velocity	500 m/s
Velocity accuracy <sup>18</sup>	0.05 m/s	
Heading accuracy <sup>18</sup>	0.3 degrees	

Parameter		GPS+GAL	GPS+GAL +GLO	GPS+GAL +BDS B1I	GPS+GAL +BDS B1C	GPS+GAL +BDS B1C +GLO
Time-To-First-Fix <sup>19</sup>	Cold start	28 s	23 s	27 s	28 s	23 s
	Hot start	1 s	1 s	1 s	1 s	1 s
	Aided starts <sup>20</sup>	1 s	1 s	1 s	1 s	1 s
Max navigation update rate <sup>21</sup>	Default	10 Hz	6 Hz	3 Hz	8 Hz	4 Hz
	High performance <sup>22</sup>	20 Hz	16 Hz	12 Hz	16 Hz	10 Hz
Sensitivity <sup>23</sup>	Tracking & Nav.	-167 dBm	-167 dBm	-167 dBm	-167 dBm	-167 dBm
	Reacquisition	-160 dBm	-160 dBm	-160 dBm	-160 dBm	-160 dBm
	Cold start	-148 dBm	-148 dBm	-148 dBm	-148 dBm	-148 dBm
	Hot start <sup>24</sup>	-159 dBm	-159 dBm	-159 dBm	-159 dBm	-159 dBm
Position accuracy <sup>25</sup>		1.5 m	1.5 m	1.5 m	1.5 m	1.5 m

Parameter		GPS	GLONASS	BeiDou B1I	Galileo	BeiDou B1C
Time-To-First-Fix <sup>19</sup>	Cold start	29 s	27 s	30 s	41 s	56 s
	Hot start	1 s	1 s	1 s	1 s	1 s
	Aided starts <sup>20</sup>	1 s	1 s	1 s	5 s	N/A
Navigation update rate <sup>21</sup>	Default	18 Hz	18 Hz	18 Hz	18 Hz	18 Hz
	High performance <sup>22</sup>	25 Hz	25 Hz	25 Hz	25 Hz	25 Hz
Sensitivity <sup>23</sup>	Tracking & Nav.	-167 dBm	-166 dBm	-160 dBm	-161 dBm	-163 dBm
	Reacquisition	-160 dBm	-158 dBm	-158 dBm	-154 dBm	-156 dBm
	Cold start	-148 dBm	-147 dBm	-146 dBm	-141 dBm	-136 dBm
	Hot start <sup>24</sup>	-159 dBm	-159 dBm	-159 dBm	-155 dBm	-157 dBm
Position accuracy <sup>25</sup>		1.5 m	4 m	2 m	3 m	2 m

**Table 15: GNSS characteristics and performance of the LENA-R8001M10 module**

<sup>16</sup> BeiDou B1I cannot be enabled simultaneously with BeiDou B1C or GLONASS L1OF

<sup>17</sup> Assuming Airborne < 4 g platform

<sup>18</sup> 50% at 30 m/s for dynamic operation

<sup>19</sup> Commanded starts. All satellites at -130 dBm. GPS always in combination with QZSS and SBAS.

<sup>20</sup> Dependent on the speed and latency of the aiding data connection.

<sup>21</sup> Minimum 98% fix rate under typical conditions.

<sup>22</sup> Configuration required.

<sup>23</sup> Good external LNA. Room temperature.

<sup>24</sup> Commanded starts.

<sup>25</sup> CEP, 50%, 24 hours static, -130 dBm, > 6 SVs for each GNSS system. GPS is always in combination with SBAS and QZSS.

## 5.2.6 Cellular LTE RF characteristics

The LTE bands supported by each LENA-R8 module are defined in [Table 2](#), while [Table 16](#) describes the transmitting and receiving frequencies for each LTE band according to 3GPP TS 36.521-1 [10].

Parameter		Min.	Max.	Unit	Remarks
Frequency range FDD Band 12 (700 MHz)	Uplink	699	716	MHz	Module transmits
	Downlink	729	746	MHz	Module receives
Frequency range FDD Band 28 (700 MHz)	Uplink	703	748	MHz	Module transmits
	Downlink	758	803	MHz	Module receives
Frequency range FDD Band 20 (800 MHz)	Uplink	832	862	MHz	Module transmits
	Downlink	791	821	MHz	Module receives
Frequency range FDD Band 5 (850 MHz)	Uplink	824	849	MHz	Module transmits
	Downlink	869	894	MHz	Module receives
Frequency range FDD Band 8 (900 MHz)	Uplink	880	915	MHz	Module transmits
	Downlink	925	960	MHz	Module receives
Frequency range FDD Band 4 (1700 MHz)	Uplink	1710	1755	MHz	Module transmits
	Downlink	2110	2155	MHz	Module receives
Frequency range FDD Band 66 (1700 MHz)	Uplink	1710	1780	MHz	Module transmits
	Downlink	2110	2200	MHz	Module receives
Frequency range FDD Band 3 (1800 MHz)	Uplink	1710	1785	MHz	Module transmits
	Downlink	1805	1880	MHz	Module receives
Frequency range FDD Band 2 (1900 MHz)	Uplink	1850	1910	MHz	Module transmits
	Downlink	1930	1990	MHz	Module receives
Frequency range FDD Band 1 (2100 MHz)	Uplink	1920	1980	MHz	Module transmits
	Downlink	2110	2170	MHz	Module receives
Frequency range TDD Band 40 (2300 MHz)	Uplink	2300	2400	MHz	Module transmits
	Downlink	2300	2400	MHz	Module receives
Frequency range TDD Band 41 (2600 MHz)	Uplink	2496	2690	MHz	Module transmits
	Downlink	2496	2690	MHz	Module receives
Frequency range TDD Band 38 (2600 MHz)	Uplink	2570	2620	MHz	Module transmits
	Downlink	2570	2620	MHz	Module receives
Frequency range FDD Band 7 (2600 MHz)	Uplink	2500	2570	MHz	Module transmits
	Downlink	2620	2690	MHz	Module receives

**Table 16: LTE operating RF frequency bands**

LENA-R8 series modules include a UE Power Class 3 LTE transmitter (see [Table 2](#)), with Tx power and characteristics according to 3GPP TS 36.521-1 [10], and one LTE receiver compliant to 3GPP TS 36.521-1 [10] with LTE conducted receiver sensitivity performance described in [Table 17](#).

Parameter	Min.	Typical	Max.	Unit	Remarks
Receiver input sensitivity Band 12 (700 MHz)	-106			dBm	Channel bandwidth = 1.4 MHz
	-101			dBm	Channel bandwidth = 5 MHz
	-98			dBm	Channel bandwidth = 10 MHz
Receiver input sensitivity Band 28 (700 MHz)	-103			dBm	Channel bandwidth = 3 MHz
	-101			dBm	Channel bandwidth = 5 MHz
	-95			dBm	Channel bandwidth = 20 MHz
Receiver input sensitivity Band 20 (800 MHz)	-102			dBm	Channel bandwidth = 5 MHz
	-96			dBm	Channel bandwidth = 20 MHz

Parameter	Min.	Typical	Max.	Unit	Remarks
Receiver input sensitivity Band 5 (850 MHz)		-106		dBm	Channel bandwidth = 1.4 MHz
		-101		dBm	Channel bandwidth = 5 MHz
		-98		dBm	Channel bandwidth = 10 MHz
Receiver input sensitivity Band 8 (900 MHz)		-106		dBm	Channel bandwidth = 1.4 MHz
		-101		dBm	Channel bandwidth = 5 MHz
		-98		dBm	Channel bandwidth = 10 MHz
Receiver input sensitivity Band 4 / 66 (1700 MHz)		-106		dBm	Channel bandwidth = 1.4 MHz
		-101		dBm	Channel bandwidth = 5 MHz
		-95		dBm	Channel bandwidth = 20 MHz
Receiver input sensitivity Band 3 (1800 MHz)		-106		dBm	Channel bandwidth = 1.4 MHz
		-101		dBm	Channel bandwidth = 5 MHz
		-95		dBm	Channel bandwidth = 20 MHz
Receiver input sensitivity Band 2 (1900 MHz)		-106		dBm	Channel bandwidth = 1.4 MHz
		-101		dBm	Channel bandwidth = 5 MHz
		-95		dBm	Channel bandwidth = 20 MHz
Receiver input sensitivity Band 1 (2100 MHz)		-101		dBm	Channel bandwidth = 5 MHz
		-95		dBm	Channel bandwidth = 20 MHz
Receiver input sensitivity Band 40 (2300 MHz)		-101		dBm	Channel bandwidth = 5 MHz
		-95		dBm	Channel bandwidth = 20 MHz
Receiver input sensitivity Band 41 (2600 MHz)		-101		dBm	Channel bandwidth = 5 MHz
		-95		dBm	Channel bandwidth = 20 MHz
Receiver input sensitivity Band 38 (2600 MHz)		-101		dBm	Channel bandwidth = 5 MHz
		-95		dBm	Channel bandwidth = 20 MHz
Receiver input sensitivity Band 7 (2600 MHz)		-100		dBm	Channel bandwidth = 5 MHz
		-94		dBm	Channel bandwidth = 20 MHz

Condition: 50  $\Omega$ , throughput > 95%, QPSK modulation, other settings as per clause 7.3EB of 3GPP TS 36.521-1 [10]

**Table 17: LTE receiver sensitivity performance**

## 5.2.7 Cellular 2G RF characteristics

The 2G bands supported by LENA-R8 series modules are defined in [Table 2](#), while [Table 18](#) describes the Transmitting and Receiving frequencies for each 2G band according to 3GPP TS 51.010-1 [11].

Parameter		Min	Max	Unit	Remarks
Frequency range GSM 850	Uplink	824	849	MHz	Module transmits
	Downlink	869	894	MHz	Module receives
Frequency range E-GSM 900	Uplink	880	915	MHz	Module transmits
	Downlink	925	960	MHz	Module receives
Frequency range DCS 1800	Uplink	1710	1785	MHz	Module transmits
	Downlink	1805	1880	MHz	Module receives
Frequency range PCS 1900	Uplink	1850	1910	MHz	Module transmits
	Downlink	1930	1990	MHz	Module receives

**Table 18: 2G operating RF frequency bands**

LENA-R8 series modules include a GMSK Power Class 4 transmitter for the 850/900 MHz bands, a GMSK Power Class 1 transmitter for the 1800/1900 MHz bands (see [Table 2](#)), with Tx power and characteristics according to 3GPP TS 51.010-1 [11], and the modules include a 2G receiver compliant to 3GPP TS 51.010-1 [11] with conducted receiver sensitivity performance described in [Table 19](#).

Parameter	Min.	Typical	Max.	Unit	Remarks
Receiver input sensitivity E-GSM 850		-107		dBm	Downlink RF level @ BER Class II < 2.4%
Receiver input sensitivity E-GSM 900		-108		dBm	Downlink RF level @ BER Class II < 2.4%
Receiver input sensitivity E-GSM 1800		-108		dBm	Downlink RF level @ BER Class II < 2.4%
Receiver input sensitivity DCS 1900		-108		dBm	Downlink RF level @ BER Class II < 2.4%

Condition: 50 Ω, other settings as per clause 14.2.1 of 3GPP TS 51.010-1 [11]

**Table 19: 2G receiver sensitivity performance**

## 5.2.8 Cellular ANT\_DET pin

Parameter	Min.	Typ.	Max.	Unit	Remarks
Output DC current pulse value		750		μA	Generated by means of the +UANTR AT command
Output DC current pulse time length		5		ms	Generated by means of the +UANTR AT command

**Table 20: ANT\_DET pin characteristics**

## 5.2.9 Cellular PWR\_ON pin

Parameter	Min.	Typical	Max.	Unit	Remarks
PWR_ON internal supply		3.8		V	The PWR_ON input is internally pulled up to VCC
Low-level input	-0.3		0.5	V	
Pull-up resistance		20		kΩ	Internal pull-up to VCC
PWR_ON low time	2.0			s	Low time to trigger cellular system switch on
	3.1			s	Low time to trigger cellular system graceful switch off

**Table 21: PWR\_ON pin characteristics**

## 5.2.10 Cellular RESET\_N pin

Parameter	Min.	Typical	Max.	Unit	Remarks
RESET_N internal supply		3.8		V	The RESET_N input is internally pulled up to VCC
Low-level input	-0.3		0.5	V	
Pull-up resistance		17		kΩ	Internal pull-up to VCC
RESET_N low time	50			ms	Low time to trigger cellular system reset (reboot)

**Table 22: RESET\_N pin characteristics**

## 5.2.11 Cellular SIM pins

The SIM pins are a dedicated interface to the external SIM card/chip. The electrical characteristics fulfill the regulatory specification requirements. The values in [Table 23](#) are for information only.

Parameter	Min.	Typ.	Max.	Unit	Remarks
Internal supply for SIM interface domain		1.8		V	VSIM supply for external 1.8 V SIM
		3.0		V	VSIM supply for external 3.0 V SIM
Low-level input	-0.3		0.3*VSIM	V	
High-level input	0.7*VSIM		VSIM+0.3	V	
Low-level output		0.0	0.3*VSIM	V	Max value at I <sub>OL</sub> = +2.0 mA
High-level output	0.7*VSIM	VSIM		V	Max value at I <sub>OL</sub> = +2.0 mA
Internal pull-up resistor on SIM_IO		10		kΩ	Internal pull-up to VSIM supply
Clock frequency on SIM_CLK		3.3		MHz	

**Table 23: SIM pins characteristics**

## 5.2.12 Cellular USB pins

USB data lines (**USB\_D+** / **USB\_D-**) are compliant with the USB 2.0 high-speed specification. See the Universal Serial Bus specification revision 2.0 [13] for detailed electrical characteristics. The values in Table 24 related to USB 2.0 high-speed physical layer specifications are for information only.

Parameter	Min.	Typical	Max.	Unit	Remarks
VUSB_DET pin, High-level input	4.50	5.00	5.25	V	
High-speed squelch detection threshold (input differential signal amplitude)	100		150	mV	
High speed disconnect detection threshold (input differential signal amplitude)	525		625	mV	
High-speed data signaling input common mode voltage range	-50		500	mV	
High-speed idle output level	-10		10	mV	
High-speed data signaling output high level	360		440	mV	
High-speed data signaling output low level	-10		10	mV	
Chirp J level (output differential voltage)	700		1100	mV	
Chirp K level (output differential voltage)	-900		-500	mV	

**Table 24: USB pins characteristics**

## 5.2.13 Cellular I2C pins

I2C lines (**SCL** and **SDA**) are compliant with the I2C-bus standard mode specification. See the I2C-bus specification [14] for detailed electrical characteristics. The values in Table 25 related to I2C-bus standard mode specifications are for information only.

Parameter	Min	Typical	Max	Unit	Remarks
Internal supply for I2C domain		1.8		V	V_INT supply
Low-level input	-0.3	0.0	0.6	V	
High-level input	1.2	1.8	2.0	V	
Low-level output		0.0	0.4	V	Max value at I <sub>OL</sub> = +2.0 mA
Internal pull-up resistance	6	20	34	kΩ	Internal active pull-up to V_INT supply
Clock frequency on SCL		100		kHz	I2C-bus standard mode

**Table 25: I2C pins characteristics**

## 5.2.14 Cellular Generic Digital Interfaces pins

Parameter	Min	Typical	Max	Unit	Remarks
Internal supply for GDI domain		1.8		V	V_INT supply
Low-level input	-0.3	0.0	0.6	V	
High-level input	1.2	1.8	2.0	V	
Low-level output		0.0	0.4	V	Max value at I <sub>OL</sub> = +2.0 mA
High-level output	1.4	1.8		V	Min value at I <sub>OH</sub> = -2.0 mA
Internal pull-up resistance	6	20	34	kΩ	Internal active pull-up to V_INT supply
Internal pull-down resistance	20	50	80	kΩ	Internal active pull-down to GND

**Table 26: Cellular Generic Digital Interfaces (GDI) pins characteristics**

### 5.2.15 Cellular smart temperature supervisor

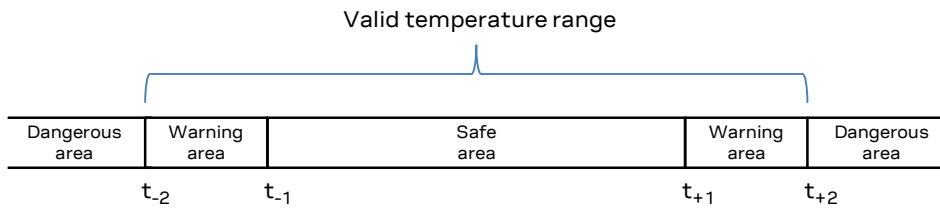

Figure 4: Temperature range and limits

Symbol	Parameter	Temperature
$t_{-2}$	Low temperature shutdown	-40 °C
$t_{-1}$	Low temperature warning	-30 °C
$t_{+1}$	High temperature warning	+80 °C
$t_{+2}$	High temperature shutdown	+90 °C

Table 27: Thresholds for the “Smart temperature supervisor” feature on the LENA-R8 series modules cellular system

The sensor measures the temperature inside the shield, that can differ from ambient temperature

### 5.2.16 GNSS peripheral I/O pins

Parameter	Min	Typical	Max	Unit	Remarks
Internal supply for GNSS domain		1.80		V	VCC_GNSS supply
Low-level input		0.0	0.6	V	
High-level input	1.2	1.8		V	
Low-level output		0.0	0.4	V	Max value at $I_{OL} = +2.0$ mA
High-level output	1.4	1.8		V	Min value at $I_{OH} = -2.0$ mA

Table 28: GNSS digital peripheral interface pins characteristics

Parameter	Specification
Time pulse signal accuracy	30 ns (RMS) 60 ns (99%)
Time pulse signal frequency	0.25 Hz to 10 MHz (configurable)

Table 29: GNSS TIMEPULSE pin characteristics

## 5.3 Parameters for ATEX applications

This section provides useful parameters and information to integrate LENA-R8 series modules in applications intended for use in areas with potentially explosive atmospheres (ATEX), describing:

- Total internal capacitance and inductance of LENA-R8 series modules (see [Table 30](#))
- Maximum RF output power at the cellular antenna pin of LENA-R8 series modules (see [Table 31](#))

Any specific applicable requirement for the implementation of the apparatus integrating the LENA-R8 series modules, intended for use in potentially explosive atmospheres, must be fulfilled according to exact applicable standards: check detailed requisites on pertinent normative for the application, as for example IEC 60079-0 [\[15\]](#), IEC 60079-11 [\[16\]](#), IEC 60079-26 [\[17\]](#) standards.

The certification of the application host device integrating a LENA-R8 series module and the compliance of the application device with all the applicable certification schemes, directives and standards required for use in potentially explosive atmospheres are the sole responsibility of the application device manufacturer.

Table 30 describes the maximum total internal capacitance and the maximum total internal inductance, considering internal parts tolerance, provided by LENA-R8 series modules.

Module	Parameter	Description	Value	Unit
LENA-R8001	Ci	Maximum total internal capacitance	180	μF
	Li	Maximum total internal inductance	4.1	μH
LENA-R8001M10	Ci	Maximum total internal capacitance	205	μF
	Li	Maximum total internal inductance	4.1	μH

**Table 30: LENA-R8 series maximum total internal capacitance and maximum total internal inductance**

Table 31 describes the maximum RF output power transmitted by LENA-R8 series modules from the cellular antenna (**ANT**) pin as Power Class 3 User Equipment for the LTE bands, Power Class 4 Mobile Station for GSM 850 / E-GSM 900 bands, and Power Class 1 Mobile Station for DCS 1800 / PCS 1900 bands.

Module	Parameter	Description	Value	Unit
LENA-R8001	ANT Pout	Maximum RF output power from ANT pin	33.0	dBm
LENA-R8001M10	ANT Pout	Maximum RF output power from ANT pin	33.0	dBm

**Table 31: LENA-R8 series cellular antenna pin (ANT) maximum RF output power**



## 6 Mechanical specifications

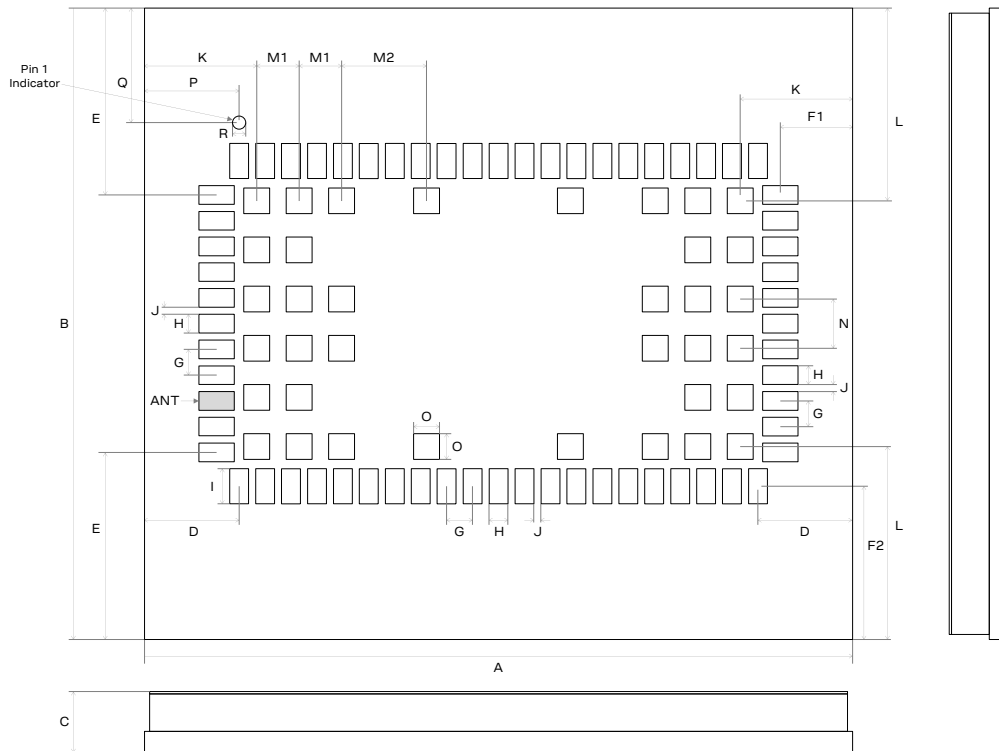

Figure 5: LENA-R8 series dimensions (bottom and side views)

Parameter	Description	Typical	Tolerance
A	Module height [mm]	30.0 (1181.1 mil)	+0.20/-0.20 (+7.9/-7.9 mil)
B	Module width [mm]	27.0 (1063.0 mil)	+0.20/-0.20 (+7.9/-7.9 mil)
C	Module thickness [mm]	2.7 (102.4 mil)	+0.27/-0.17 (+10.6/-6.7 mil)
D	Horizontal edge to lateral pin pitch [mm]	4.0 (157.5 mil)	+0.20/-0.20 (+7.9/-7.9 mil)
E	Vertical edge to lateral pin pitch [mm]	8.0 (315.0 mil)	+0.20/-0.20 (+7.9/-7.9 mil)
F1	Edge to lateral pin pitch [mm]	3.05 (120.1 mil)	+0.20/-0.20 (+7.9/-7.9 mil)
F2	Edge to lateral pin pitch [mm]	6.55 (257.9 mil)	+0.20/-0.20 (+7.9/-7.9 mil)
G	Lateral pin to pin pitch [mm]	1.1 (43.3 mil)	+0.05/-0.05 (+2.0/-2.0 mil)
H	Lateral pin height [mm]	0.8 (31.5 mil)	+0.05/-0.05 (+2.0/-2.0 mil)
I	Lateral pin width [mm]	1.5 (59.1 mil)	+0.05/-0.05 (+2.0/-2.0 mil)
J	Lateral pin to pin distance [mm]	0.3 (11.8 mil)	+0.05/-0.05 (+2.0/-2.0 mil)
K	Horizontal edge to central pin pitch [mm]	4.75 (187.0 mil)	+0.20/-0.20 (+7.9/-7.9 mil)
L	Vertical edge to central pin pitch [mm]	8.25 (324.8 mil)	+0.20/-0.20 (+7.9/-7.9 mil)
M1	Central pin to pin horizontal pitch [mm]	1.8 (70.9 mil)	+0.05/-0.05 (+2.0/-2.0 mil)
M2	Central pin to pin horizontal pitch [mm]	3.6 (141.7 mil)	+0.05/-0.05 (+2.0/-2.0 mil)
N	Central pin to pin vertical pitch [mm]	2.1 (82.7 mil)	+0.05/-0.05 (+2.0/-2.0 mil)
O	Central pin height and width [mm]	1.1 (43.3 mil)	+0.05/-0.05 (+2.0/-2.0 mil)
P	Horizontal edge to pin 1 indicator pitch [mm]	2.9 (114.2 mil)	+0.20/-0.20 (+7.9/-7.9 mil)
Q	Vertical edge to pin 1 indicator pitch [mm]	6.5 (255.9 mil)	+0.20/-0.20 (+7.9/-7.9 mil)
R	Pin 1 indicator height and width [mm]	0.6 (23.6 mil)	+0.05/-0.05 (+2.0/-2.0 mil)
Weight	Module weight [g]	4	

Table 32: LENA-R8 series dimensions

Module height / width tolerance  $\pm 0.20$  mm may be exceeded due to the PCB tab cutting process. In the worst case, the height / width could be  $+0.40$  mm more than the typical value.

For information regarding footprint and paste mask recommended for the application board integrating the cellular module, see section the LENA-R8 series system integration manual [2].

## 7 Qualification and approvals

### 7.1 Reliability tests

Reliability tests for LENA-R8 series modules are executed according to u-blox qualification policy for standard grade products.

### 7.2 Approvals

LENA-R8 series modules comply with the Directive 2011/65/EU of the European Parliament and the Council on the Restriction of Use of certain Hazardous Substances in Electrical and Electronic Equipment (EU RoHS 2) and its amendment Directive (EU) 2015/863 (EU RoHS 3).

LENA-R8 series modules are RoHS 3 compliant.

No natural rubbers, hygroscopic materials, or materials containing asbestos are employed.

[Table 33](#) summarizes the main approvals for LENA-R8 series modules.

Certification scheme	LENA-R8001	LENA-R8001M10
GCF conformance	•	•
CE (Europe)	•	•
UKCA (Great Britain)	•	•
FCC (United States)	•	•
FCC ID	XPYUBX22EL01	XPYUBX22EL01
ISED (Canada)	•	•
ISED certification number	8595A-UBX22EL01	8595A-UBX22EL01
ACMA RCM (Australia)	•	•

**Table 33: LENA-R8 series main certification approvals summary**

 The above listed certifications might not be available for all the different product type numbers. Please contact the u-blox office or sales representative near you for the complete list of certification approvals available for the selected product ordering number.

## 8 Product handling & soldering

### 8.1 Packaging

LENA-R8 series modules are delivered as hermetically sealed reeled tapes, in quantities of 250 pieces on a reel, to enable efficient production, production lot set-up and tear-down. Quantities of less than 250 pieces are also available. Contact u-blox for more information.

For more information about packaging, see the u-blox package information user guide [6].

#### 8.1.1 Reels

LENA-R8 series modules are deliverable in quantities of 250 pieces on a reel. The modules are delivered using the reel type described in Figure 6.

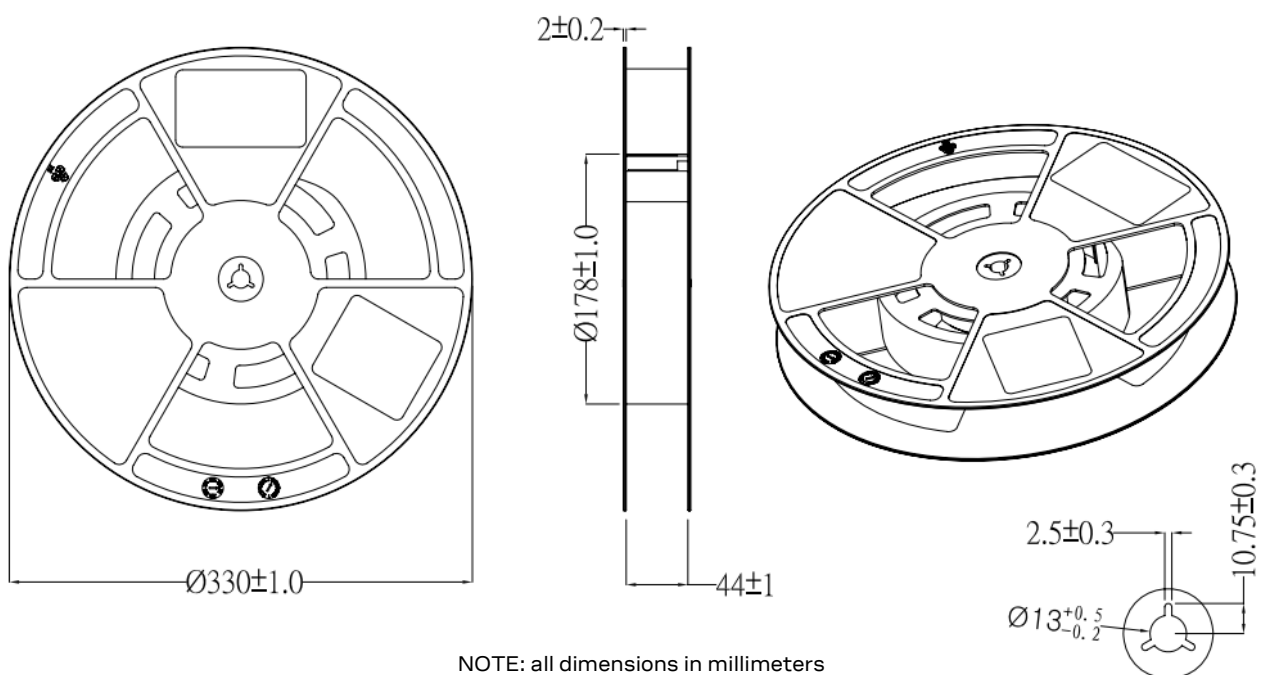

Figure 6: LENA-R8 series modules reel

Quantities of less than 250 pieces are also available. Contact u-blox for more information.

### 8.1.2 Tapes

Figure 7 shows the position and the orientation of LENA-R8 series modules as they are delivered on the tape, while Figure 8 indicates the tape dimensions.

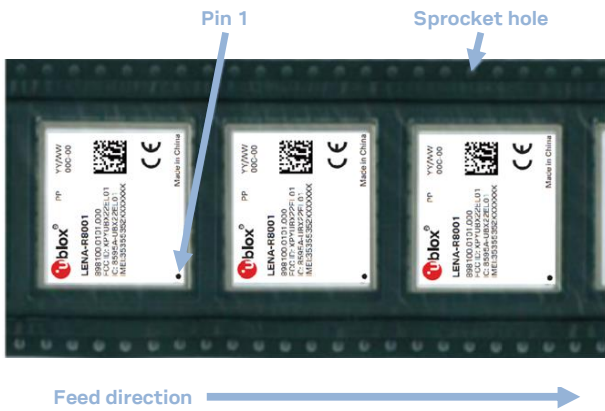
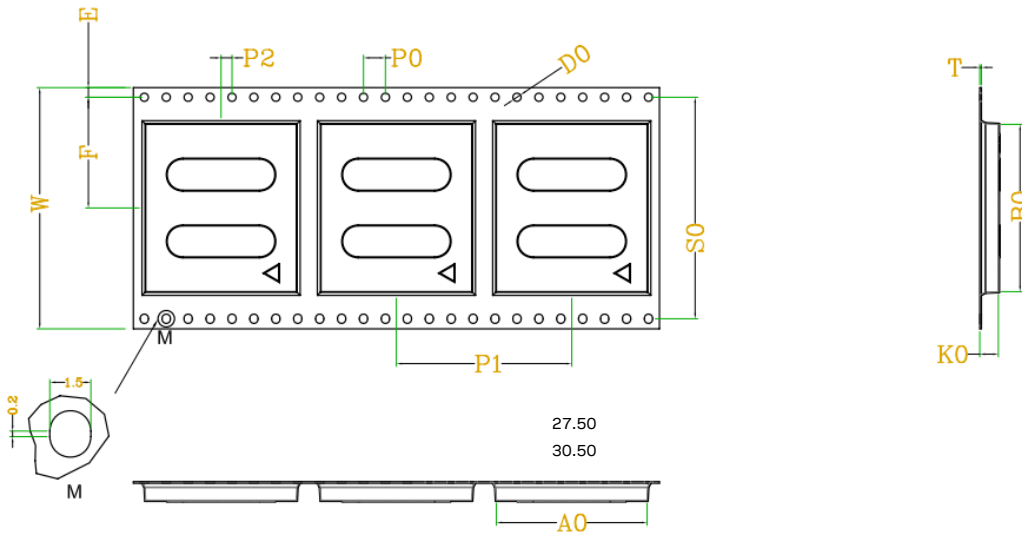

Figure 7: Orientation for LENA-R8 series modules on tape



	$S_1 \text{ } \textcircled{\circ}$	$D_1 \text{ } \textcircled{\circ}$	$D_1 \text{ } \textcircled{\circ}$	$P_1 \text{ } \textcircled{\circ}$	$P_2 \text{ } \textcircled{\circ}$	$E \text{ } \textcircled{\circ}$			
	$40.4^{+0.10}_{-0.10}$	$1.50^{+0.10}_{-0.00}$	$0.00^{+0.10}_{-0.00}$	$4.00 \pm 0.10$	$2.00 \pm 0.10$	$1.75 \pm 0.10$			
ITEM	$W \text{ } \textcircled{\circ}$	$A_1 \text{ } \textcircled{\circ}$	$A_1 \text{ } \textcircled{\circ}$	$B_1 \text{ } \textcircled{\circ}$	$K_1 \text{ } \textcircled{\circ}$	$K_1 \text{ } \textcircled{\circ}$	$P_1 \text{ } \textcircled{\circ}$	$F \text{ } \textcircled{\circ}$	$T \text{ } \textcircled{\circ}$
DIM	$44.00 \pm 0.30$	$27.50 \pm 0.10$	$\pm 0.10$	$30.50 \pm 0.10$	$\pm 0.10$	$\pm 0.10$	$32.0 \pm 0.10$	$20.20 \pm 0.15$	$0.30 \pm 0.05$
ALTERNATE									

Figure 8: LENA-R8 series modules tape dimensions

## 8.2 Moisture sensitivity levels

- ⚠ The modules are Moisture Sensitive Devices (MSD) in accordance to the IPC/JEDEC specification. The Moisture Sensitivity Level (MSL) relates to the packaging and handling precautions required. LENA-R8 series modules are rated at MSL level 4. For more information regarding moisture sensitivity levels, labeling, storage and drying see the u-blox package information user guide [6].

📄 For the MSL standard, see IPC/JEDEC J-STD-020 (can be downloaded from [www.jedec.org](http://www.jedec.org)).

## 8.3 ESD precautions

- ⚠ The LENA-R8 series modules contain highly sensitive electronic circuitry and are Electrostatic Sensitive Devices (ESD). Handling LENA-R8 series modules without proper ESD protection may destroy or damage them permanently.
- ⚠ Ensure ESD precautions are implemented during handling of the module.



Electrostatic discharge (ESD) is the sudden and momentary electric current that flows between two objects at different electrical potentials caused by direct contact or induced by an electrostatic field. The term is usually used in the electronics and other industries to describe momentary unwanted currents that may cause damage to electronic equipment.

Table 7 details the maximum ESD ratings of the LENA-R8 series modules.

ESD precautions should be appropriately implemented on the application board where the module is mounted, for the relevant lines externally accessible on the application board.

Proper ESD handling and packaging procedures must be applied throughout the processing, handling and operation of any application that incorporates LENA-R8 series modules.

For details about ESD precautions, see the LENA-R8 series system integration manual [2].

- ⚠ Failure to observe these precautions can result in severe damage to the device!

## 8.4 Soldering

Reflow profiles are to be selected according to u-blox recommendations (see the LENA-R8 series system integration manual [2]).

- ⚠ Failure to observe these recommendations can result in severe damage to the device!

## 9 Labeling and ordering information

### 9.1 Product labeling

The label of LENA-R8 series modules include important product information as described in [Figure 9](#), as the label includes: u-blox logo, production lot, Pb-free marking, product type number, IMEI number, applicable regulatory certifications' info, and production country.



Figure 9: Illustrative example of LENA-R8 series modules' label

### 9.2 Explanation of codes

Three different product code formats are used. The Product Name is used in documentation such as this data sheet and identifies all the u-blox products, independent of packaging and quality grade. The Ordering Code includes options and quality, while the Type Number includes the hardware and firmware versions. [Table 34](#) details these 3 different formats:

Format	Structure
Product name	PPPP-TGVV(L)(HH)
Ordering code	PPPP-TGVV(L)(HH)-MMQ
Type number	PPPP-TGVV(L)(HH)-MMQ-XX

Table 34: Product code formats

[Table 35](#) explains the parts of the product code.

Code	Meaning	Example
PPPP	Form factor	LENA
TG	Platform (technology and generation) <ul style="list-style-type: none"> <li>Dominant technology: G: GSM; U: UMTS; C: CDMA 1xRTT; N: NB-IoT (LTE Cat NB1/NB2); R: LTE low data rate (Cat 1, Cat 1bis, Cat M1); L: LTE high data rate (Cat 3 and above)</li> <li>Generation: 1...9</li> </ul>	R8
VV	Variant function set based on the same platform: 00...99	00
(L)	LTE category (optionally indicated): 6,4,3,1,M ...	1
(HH)	GNSS generation (indicated if supported): M8 = u-blox M8, M9 = u-blox M9, M10 = u-blox M10,...	M10
MM	Major product version: 00...99	00
Q	Product grade: C = standard, B = professional, A = automotive	C
XX	Minor product version: 00...99	00

Table 35: Part identification code

## 9.3 Ordering information

Ordering number	Product
LENA-R8001-00C	Global LTE FDD / TDD Cat 1 bis module with 2G fallback. 30.0 x 27.0 x 2.7 mm, 250 pcs/reel
LENA-R8001M10-00C	Global LTE FDD / TDD Cat 1 bis module with 2G fallback and integrated u-blox M10 GNSS receiver. 30.0 x 27.0 x 2.7 mm, 250 pcs/reel

**Table 36: Product ordering codes**

# Appendix

## A Glossary

Abbreviation	Definition
2G	2nd Generation Cellular Technology (GSM, GPRS)
3G	3rd Generation Cellular Technology (UMTS, HSPA)
3GPP	3rd Generation Partnership Project
ADC	Analog to Digital Converter
AT	AT Command Interpreter Software Subsystem, or attention
AUX	Auxiliary
BDS	BeiDou (Chinese satellite navigation system)
BIP	Bearer Independent Protocol
CaaS	Communication-as-a-Service
Cat	Category
CDC-ECM	Communications Device Class – Ethernet Control Model
CE	European Conformity
CEP	Circular Error Probable
CMOS	Complementary Metal-Oxide-Semiconductor
CSFB	Circuit Switched Fall-Back
DC	Direct Current
DCE	Data Communication Equipment
DCS	Digital Cellular System
DDC	Display Data Channel (I2C compatible) Interface
DL	Down-link (Reception)
DNS	Domain Name System
DTE	Data Terminal Equipment
DTLS	Datagram Transport Layer Security
E2E	End-to-End
eDRX	Extended Discontinuous Reception
EGNOS	European Geostationary Navigation Overlay Service
ERS	External Reset input Signal
ESD	Electrostatic Discharge
EU	European Union
FCC	Federal Communications Commission (United States)
FDD	Frequency Division Duplexing
FOAT	Firmware update Over AT commands
FOTA	Firmware update Over The Air
FTP	File Transfer Protocol
FW	Firmware
GAGAN	GPS-aided GEO augmented navigation
GAL	Galileo (European satellite navigation system)
GCF	Global Certification Forum
GDI	Generic Digital Interfaces (power domain)
GLONASS	Russian global navigation satellite system
GMSK	Gaussian Minimum-Shift Keying modulation



Abbreviation	Definition
GND	Ground
GNSS	Global Navigation Satellite System
GPIO	General Purpose Input Output
GPRS	General Packet Radio Service
GPS	Global Positioning System
GSM	Global System for Mobile communications
HBM	Human Body Model
HDLC	High-level Data Link Control
HTTP	HyperText Transfer Protocol
I2C	Inter-Integrated Circuit Interface
I2S	Inter-IC Sound Interface
IEC	International Electrotechnical Commission
IMEI	International Mobile Equipment Identity
IMS	IP Multimedia Subsystem
IoT	Internet of Things
IP	Internet Protocol
ISED	Innovation, Science and Economic Development (Canada)
KMS	Key Management Service
LaaS	Location-as-a-Service
LDO	Low Drop Out
LGA	Land Grid Array
LNA	Low Noise Amplifier
LPWA	Low Power Wide Area
LTE	Long Term Evolution
LWM2M	Open Mobile Alliance Lightweight Machine-to-Machine protocol
MNO	Mobile Network Operator
MQTT	Message Queuing Telemetry Transport
MQTT-SN	Message Queuing Telemetry Transport for Sensor Networks
MSAS	Multi-functional Satellite Augmentation System
MUX	Multiplexer
N/A	Not Applicable
NMEA	National Marine Electronics Association
PA	Power Amplifier
PCB	Printed Circuit Board
PCS	Personal Communications Service
PD	Pull-Down
PDP	Packet Data Protocol
PMU	Power Management Unit
POS	Power-On input Signal
PPP	Point-to-Point Protocol
PSM	Power Saving Mode
PU	Pull-Up
PVT	Position Velocity Time
QZSS	Quasi-Zenith Satellite System
RAT	Radio Access Technology
RED	Radio Equipment Directive

Abbreviation	Definition
RMC	Reference Measurement Channel
RNDIS	Remote Network Driver Interface Specification
RoHS	Restriction of Hazardous Substances
RTC	Real Time Clock
Rx	Receiver
SaaS	Security -as-a-Service
SAW	Surface Acoustic Wave
SBAS	Satellite-Based Augmentation System
SCL	Serial Clock
SDA	Serial Data
SIM	Subscriber Identification Module
SKU	Stock Keeping Unit
SLAS	Sub-meter Level Augmentation Service
SPG	Standard Precision GNSS
SSL	Secure Sockets Layer
TBD	To Be Defined
TCP	Transmission Control Protocol
TCXO	Temperature-Controlled Crystal Oscillator
TDD	Time Division Duplexing
TLS	Transport Layer Security
Tx	Transmitter
UART	Universal Asynchronous Receiver/Transmitter serial interface
UDP	User Datagram Protocol
UL	Up-link (Transmission)
USB	Universal Serial Bus
VoLTE	Voice over LTE
WAAS	Wide Area Augmentation System

## Related documentation

- [1] u-blox LENA-R8 series AT commands manual, [UBX-22016905](#)
- [2] u-blox LENA-R8 series system integration manual, [UBX-22015376](#)
- [3] u-blox UBX-M10050-KB standard precision GNSS chip data sheet, [UBX-20043795](#)
- [4] u-blox UBX-M10050-KB standard precision GNSS chip integration manual, [UBX-20049918](#)
- [5] u-blox M10 SPG 5.10 interface description, [UBX-21035062](#)  
u-blox packaging information user guide, [UBX-14001652](#)
- [7] 3GPP TS 27.007 - AT command set for User Equipment (UE)
- [8] 3GPP TS 27.005 - Use of Data Terminal Equipment - Data Circuit terminating Equipment (DTE - DCE) interface for Short Message Service (SMS) and Cell Broadcast Service (CBS)
- [9] 3GPP TS 27.010 - Terminal Equipment to User Equipment (TE-UE) multiplexer protocol
- [10] 3GPP TS 36.521-1 - Evolved Universal Terrestrial Radio Access; User Equipment conformance specification; radio transmission and reception; part 1: conformance testing
- [11] 3GPP TS 51.010-1 - Mobile Station conformance specification; part 1: conformance specification
- [12] ITU-T recommendation V24, 02-2000. List of definitions for interchange circuits between Data Terminal Equipment (DTE) and Data Connection Equipment (DCE)
- [13] Universal Serial Bus specification, revision 2.0, <https://www.usb.org/>
- [14] I2C-bus specification and user manual - UM10204, <https://www.nxp.com/>
- [15] IEC 60079-0 - Explosive atmospheres, part 0: equipment general requirements
- [16] IEC 60079-11 - Explosive atmospheres, part 11: equipment protection by intrinsic safety 'i'
- [17] IEC 60079-26 - Explosive atmospheres, part 26: equipment with EPL Ga

 For regular updates to u-blox documentation and to receive product change notifications, register on our homepage ([www.u-blox.com](http://www.u-blox.com)).

## Revision history

Revision	Date	Name	Comments
R01	06-Jul-2022	sses	Initial version.
R02	30-Sep-2022	sses	Updated LENA-R8001-00C product status. Revised UART interfaces capabilities. Added Ethernet-over-USB capabilities. Revised cellular V_BCKP characteristics. Revised cellular current consumption. Other minor clarifications and corrections.
R03	14-Apr-2023	sses	Updated LENA-R8001M10-00C product status. Revised futures available or planned for initial and future product FW versions (auxiliary UART, I2C, I2S, clock output, PSM, eDRX, SIM detection, Antenna dynamic tuning). Revised VoLTE and CSFB support. Revised power consumption and Rx sensitivity data. Revised Reels and Tapes info. Added regulatory approval for Australia. Other minor clarifications and corrections.
R04	28-Sep-2023	psca/sses	Updated LENA-R8001-00C and LENA-R8001M10-00C product status. Clarified absolute maximum ratings for ANT_GNSS pin. Clarified DTLs feature. Updated maximum GNSS navigation update rates, VBCKP_GNSS minimum operating voltage, and added BeiDou B1C characteristics and performance for LENA-R8001M10. Other minor clarifications and corrections.

# Contact

## u-blox AG

Address: Zürcherstrasse 68  
8800 Thalwil  
Switzerland

For further support and contact information, visit us at [www.u-blox.com/support](http://www.u-blox.com/support).